

Fuse Box

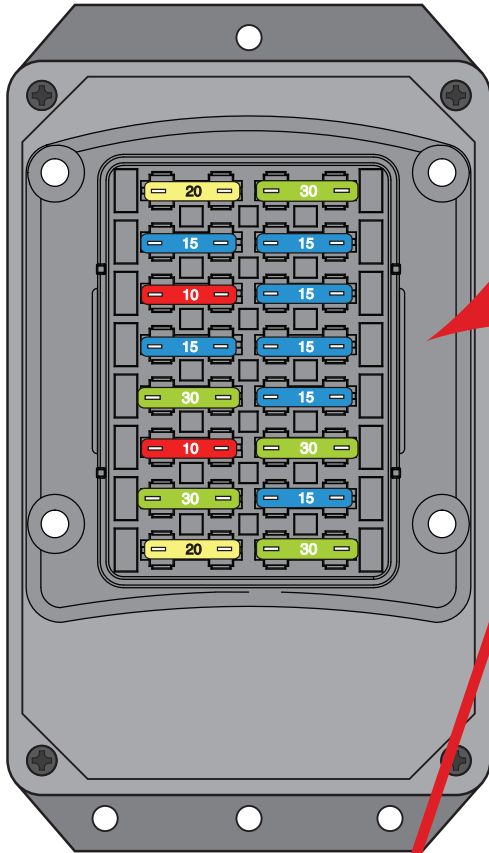

Fuse Box Lid

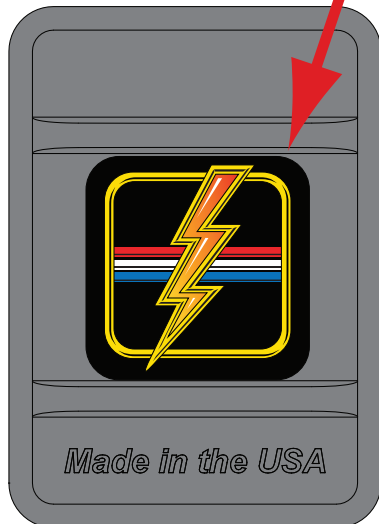

**NOTE:**

If your fuse box and fuse box lid look like this, these **ARE** the correct instructions for your application. If the word "BUSSMANN" appears on your fuse box or fuse box lid, you have an earlier version of this kit and these **ARE NOT** the correct instructions.

**KIT BOX CONTENTS:**

<u>Number</u>	<u>Description</u>
510476	Alternator and Main Power Connection Kit
510880	Main Harness Kit w/ AAW Fuse Panel
510461	Instrument Cluster Wiring Kit
510465	Front Light Wiring Kit
510466	Engine Wiring Kit
510568	Rear Body Wiring Kit
500042	Dimmer Switch
510054	Headlight Switch
510128	Ignition Switch
510469	Fuse, Relay & Flasher Kit
500919	Practice Terminal Kit
92973555	Kit Instruction Sheets
92972154	Fuse Box Bracket Mounting Template
92972156	Relay Bank Mounting Template



**American  
Autowire**

www.americanautowire.com 856-933-0801

Classic Update Kit  
1964-66 Mustang  
**510125**

92973799 Rev. 0.0 03/22/2024



**WARNING:**

Validate the kit contents with the component list included on this page, before proceeding. This kit is intended to be used in a modified vehicle. Please read this page thoroughly and be sure that you understand everything explained on it prior to opening any of the enclosed packages, or before attempting to install any of the components. Once this kit has been opened or a component installed, the kit is not returnable.

1. This kit should typically be used in a **MODIFIED 1964-1966 Mustang** application only.
2. Some early production 1964 1/2 Mustangs used a unique headlight switch assembly that utilized a shorter knob and shaft assembly than the later production 1965 - 66 cars used (3.63" vs. 3.90"). The new AAW switch included with this kit is an exact replacement for the later 1965-66 cars and needs the later production style knob and shaft in order to operate. If your car is an early production 1964 1/2 model, you will need to purchase the newer long style knob and shaft assembly from your favorite Mustang parts supplier as your original will be too short to operate the new AAW switch assembly..
3. This kit **DOES NOT** support the use of the stock generator warning lamp. A voltmeter is recommended as a good source to monitor your charging system.
4. This kit **DOES NOT** provide wiring for combination factory air conditioning & heater systems. Wiring for factory heater-only systems is provided. This kit is also compatible with aftermarket A/C systems and factory air conditioning & heater combination systems with additional customer-supplied wiring.
5. This kit only supports the use of a higher-current, self-exciting, 1-wire, or other style internally regulated alternator. An adapter may be necessary for certain applications. **No stock 1964-66 alternators are supported.**
6. This kit **WILL NOT** support the use of a factory ammeter. All AAW kits are engineered to supply the optimum charge to the battery. To achieve this performance, we route our 6ga. charge wire directly from the alternator output terminal to the starter solenoid. Due to the path of the charge being altered from the stock configuration, the gauge can no longer see a charge vs. a discharge, so it will not work properly. When ammeters were originally used, most generator or alternator current outputs were rated at maximum of about 25-60 amps. Modified cars being built today typically utilize a 100 amp or higher output alternator. With these higher current units, ammeters, generally speaking, become a safety hazard. Ammeters are usually wired in parallel to the charging circuit, are typically unfused, and can short very easily causing a fire. A voltmeter is recommended as a good alternative.
7. This kit **WILL NOT** support the use of a factory tachometer in it's original connection application as those tachs wired the primary ignition circuit directly in series through the tach and then out to the positive side of the coil. With this type of connection, any type of MSD or high energy ignition will generally destroy the internal circuitry of the tach and will cause the car to quit running as voltage will no longer flow through the tach and out to the coil or ignition control unit. **HOWEVER**, if your factory tach has been upgraded or retrofitted to a later style movement where the pulse post on the tach gets wired to the negative side of the coil (or to the tach output on an MSD box or similar unit) and the feed post of the tach uses a conventional 12 volt ignition connection, **you will be able to use this harness system.**
8. This kit **IS NOT** set up with a resistance wire for a standard, points type ignition system. It is wired with a full 12 volt primary ignition feed that is hot in both the start and run positions. It will support HEI, MSD, other electronic ignition systems, as well as computerized Fuel Injection systems. If you wish to run a points type system, there are illustrations on the engine connection pages to do so. Extra parts that are not included in this kit will be required to complete that operation.

## 510125 - Classic Update Series Kit 1964-66 Mustang

This kit contains the following components:

Bag	Part Number	Description	Quantity
	510054	Headlight Switch	1
	510469	Fuse, Relay, and Flasher kit	1
	500042	Dimmer Switch	1
	510128	Ignition Switch	1
	500919	Practice Terminal Crimping Set	1
G	510880	Dash Harness kit	1
H	510461	Instrument Cluster wiring kit	1
J	510466	Engine Wiring Kit	1
L	510465	Front Light Wiring kit	1
M	510468	Rear Body Wiring kit	1
Z	510476	Alt. & Main Power Connection Kit	1

Validate the kit contents with this component list. If there are any discrepancies with incorrect or missing parts, stop your installation and notify the supplier you purchased the kit from before proceeding.



www.americanautowire.com 856-933-0801

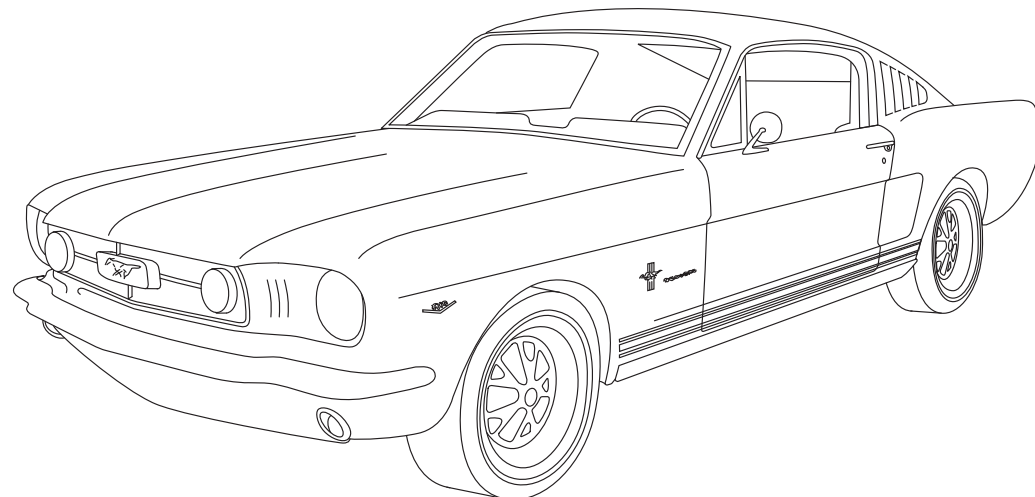

# 1964-66 Mustang

## Classic Update Series

# 510125

© COPYRIGHT 2004 American Autowire / Factory-Fit  
Used with express permission of  
American Autowire / Factory-Fit

92973555 Rev 2.0 3/1/2024



# START HERE !

## PLEASE READ THIS BEFORE STARTING INSTALLATION !

This wiring kit is designed for ease of installation. Please read the guidelines below, BEFORE STARTING your installation, to guarantee a successful job. Use an appropriate crimping tool, which folds the wings of the open barrel terminals down into the wire, as shown on this page. If you use our crimping tools and correctly crimp the included terminals, soldering is not necessary. If you are unsure about a particular crimp, soldering is recommended. Our factory crimped terminations are installed by GM approved five ton presses, and soldering these terminations is not necessary.



AAW offers a great terminal crimping video entitled "Proper Crimping Video". It can be viewed by visiting YouTube.

Type the following address into your web browser, to go directly to the video:  
[www.youtube.com/watch?v=JAgEDoVI-co](http://www.youtube.com/watch?v=JAgEDoVI-co)

Youtube Channel:  
[www.youtube.com/user/WiringHarness](http://www.youtube.com/user/WiringHarness)



The terminals that we supply in our kits, utilize what is known as an F crimp. The F crimp, in a cross section, will look like the illustration below, when done correctly.

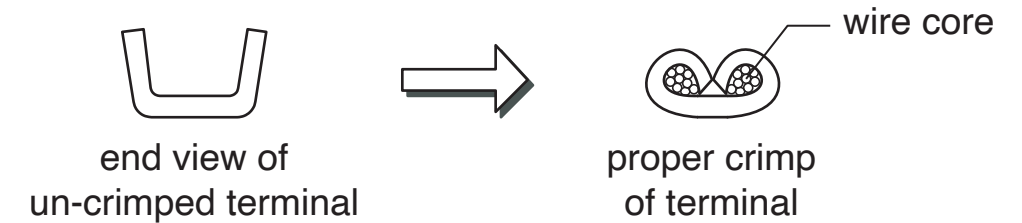

We carry the following crimping hand tools, to help with your terminal crimping. These hand tools are available, for purchase or rental.

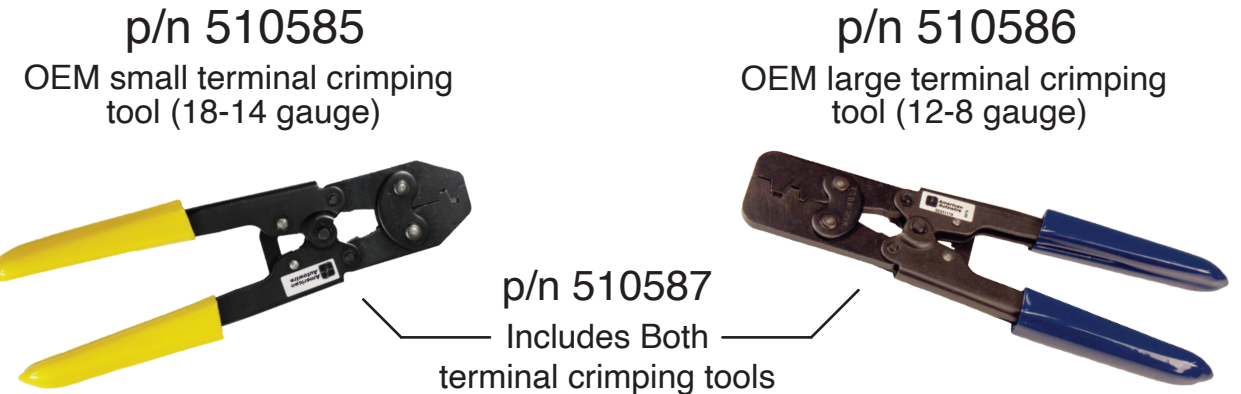

## We carry many accessories for your 1964-66 Mustang:

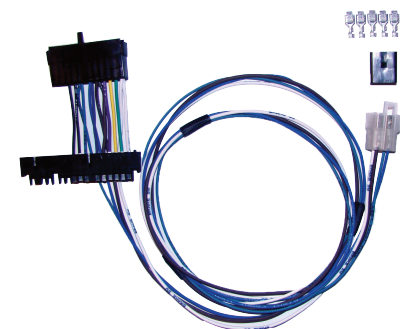

p/n 510175  
factory hazard switch  
wiring kit

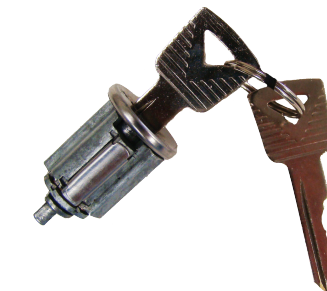

p/n 510127  
ignition switch lock  
cylinder and keys



p/n R0067108  
OEM style non-stick  
harness tape

### STEP 1: DISCONNECT YOUR BATTERY:

Disconnect the battery, before installing the wiring kit, to prevent any accidental shorting caused by loose bare wire ends.



If you have any questions concerning this or any of our products, please feel free to call us at 1-856-933-0801.

## STEP 2: START INSTALLING KIT:

This kit is broken down into individual sections, that are identified by a letter printed on the enclosed sheets, visible through each bag. The order of installation and the pages with their installation instructions, are shown below:

## Table of Contents:

### Bags: Pages: Sections:

- G** 4 - 9 Dash Harness - This is the main harness in the kit and contains:
- Heater feed and switch connections.
  - Door jamb switch and door courtesy feed connections.
  - Ignition, lighting, dimmer switch and wiper feed connections.
  - Neutral safety and back up light switch connections.
- H** 10 - 14 Gauge Cluster Harness - This Harness contains:
- Gauge connections for aftermarket and factory gauges.
- J** 15 - 16 Engine Harness - This Harness contains:
- Temperature, oil pressure, tachometer wiring.
  - Ignition system / ECU power.
  - Alternator connections.
  - Starter solenoid connections.
  - Main panel feed connections.
- L** 17 - 18 Front Light Harness - This Harness contains:
- Headlight, turn signal, running light connections.
  - Electric fan relay trigger.
  - Fog light connections.
  - Brake warning light connections.
  - Horn connections.
- M** 19 - 20 Rear Body Harness - This Harness contains:
- Tail light, turn signal, reverse light, running light and third brake light connections.
  - Fuel tank sender connections.
  - Dome light connections.



## PLEASE READ THIS HELPFUL INSTALLATION TIP, BEFORE GOING ANY FURTHER!

Prior to installing the Dash/Main harness in your dashboard, plug all of the fuses into the Fuse Box (see detailed picture below) and the Hazard Flasher and Turn Flasher and Headlights, Fog Lights and Horn Relays into this harness (see detailed pictures below).

Batt - Spare 30A - BAT	1	9	Wiper 20A - ACC
Clock/Radio 15A - BAT	2	10	Heat/AC 30A - ACC
Power Seat 30A - BAT	3	11	Radio 10A - ACC
Cigar - Lighter 20A - BAT	4	12	Engine Fan 30A - ACC
Power Locks 20A - BAT	5	13	Turn 15A - IGN
Stop/Courtesy 15A - BAT	6	14	Gauges, B/U 10A - IGN
Hazard 15A - BAT	7	15	Elec. Choke 15A - IGN
Pwr. Window 30A - IGN	8	16	Fuel Pump 20A - IGN

Fuse label  
on inside  
of Fuse  
Box cover

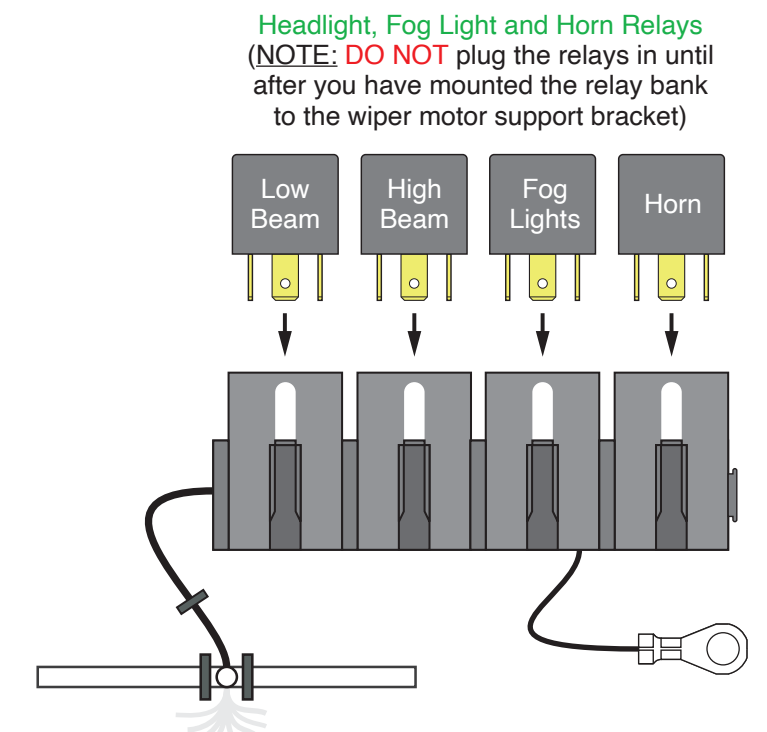
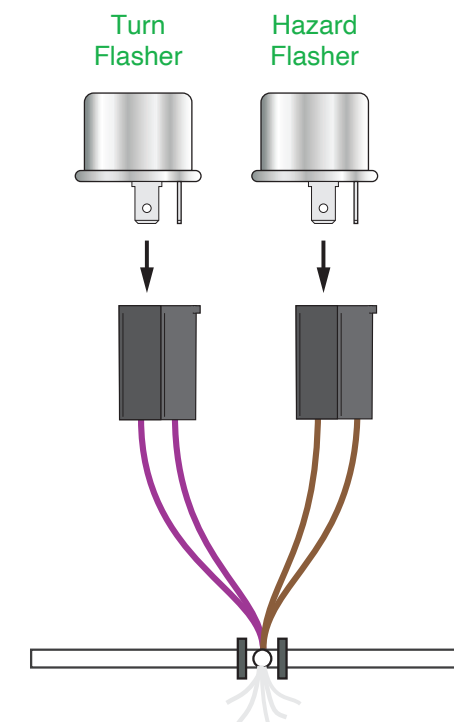
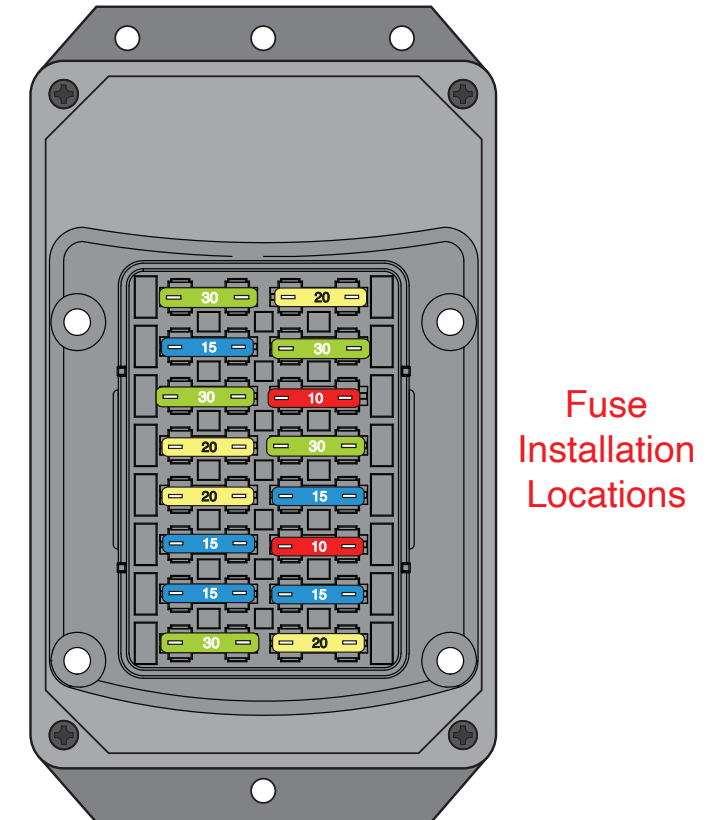

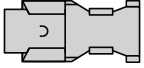

# Dash/Main harness installation instructions:

Shown below, are the supplied misc. terminals, plastic connector bodies, hardware, jumpers and extensions, included in the Dash/Main Harness Loose Piece Kit (510125) 92973539, that will be used to complete your Dash/Main harness connections. They are itemized and referred to on this page, just as they are on the following pages of this Dash/Main instruction set.

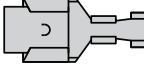
**A**  (56 series double female terminal, 8 pcs.)

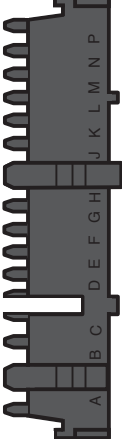
**B**  (56 series single female terminal, 3 pcs.)

**C**  (Pack-Con 14-way male connector, 1 pc.)

**D**  (Pack-Con male terminal, 11 pcs.)

**E**  (fuse panel mounting bracket, 1 pc.)

**F**  (1" fuse box mounting screw, 2 pcs.)

**G**  (1/4" lock washer, 2 pcs.)

**H**  (8-32 x 9/16 Phillips screw, 3 pcs.)

**J**  (8-32 locking nut, 3 pcs.)

**K**  (#10 flat washer, 3 pcs.)

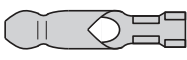
**L**  (male bullet terminal, 3 pcs.)

**M**  (small rubber sleeve, 3 pcs.)

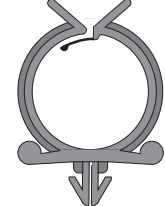
**N**  (routing clip, 2 pcs.)

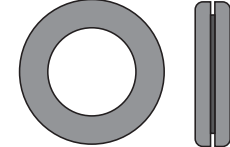
**P**  (grommet, 2 pcs.)

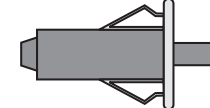
**R**  (door jamb switch, 2 pcs.)

**T**  (3-way female connector, 1 pc.)

**U**  (58 series single female terminal, 5 pcs.)

**V**  (58 series single female connector, 1 pc.)

**W**  (single female terminal, 2 pcs.)

**Y**  (large rubber sleeve, 1 pc.)

**BB**  (NSS jumper wire for manual trans, 1 pc.)

**CC**  (NSS wires from dash connection to switch, 2 pcs.)

**DD**  (1964-68 high speed blower wire, 1 pc.)

**EE**  (1964-65 low speed blower wire, 1 pc.)

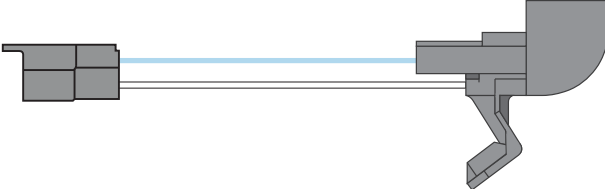
**FF**  (Courtesy Light Wiring Extensions, 2 pcs.)

**GG**  (B/U wires from dash connection to switch, 1 pc.)





# Dash/Main fusebox /bracket/ harness assembly mounting instructions:



www.americanautowire.com 856-933-0801

1964-66 Mustang  
Classic Update Series  
510125 92973555 Rev 2.0 3/1/2024

1. Make sure you have installed all of your fuses into the fusebox. Assemble the mounting bracket to the fusebox and harness assembly as shown in step #1 on this page.
2. Attach completed "bracket, fusebox and harness assembly" into the vehicle as shown in steps #2 through #6 on this page.
3. Plug H/L switch 510054 into harness connector and install into your dash. Plug your existing wiper harness into the white wiper feed wire on the AAW dash harness, onto your existing wiper switch and over to your wiper motor.
4. Plug ignition switch 510128 into harness connector, attach brown wire with ring terminal to threaded stud, plug tan wire onto ground blade of the ignition switch and install completed assembly into your dash. Plug in your cigar lighter connection.
5. Route the front light and dimmer connections back around the fresh air vent so that the front light connections are at the pass-through hole in the firewall, then route the dimmer connections down to the floor area and attach to dimmer switch 500042. Secure dimmer switch to the toeboard/floor. Plug in front light wiring 510465. After installing firewall grommet "P" in the opening, route wires out to the engine bay. See pages 18 and 19 for details.
6. Drop rear body connector down inside the door hinge pillar to the floor. Plug your in rear body harness 501468, then it route along the door sill back to the trunk area. See pages 20 and 21 for connection details.
7. Plug brake switch connection onto your existing brake switch.
8. From page 10, assemble NSS and B/U switch extension and plug onto dash harness connection.
9. Route the engine connections to the pass-through hole in the firewall. Plug in engine harness wiring 510466. After installing firewall grommet "P" in the opening, route wires out to the engine bay. See pages 16 and 17 for details. Make LH door switch and courtesy lamp (to right of column) connections. See pages 6 and 9 for details.
10. Plug in your steering column connections. See page 8 for details.
11. Build your gauge cluster harness and plug the finished assembly into the dash harness connections as shown on page 6. See pages 11-15 for details on building your cluster harness. Please note that there are several different choices and be sure you have picked the proper choice for your car's application.
12. Mount relay bank to wiper motor support bracket. See template 92972156 for instructions and details.
13. Build your heat and A/C connections. See page 10 for details.
14. Pass remaining harness over past the radio and heater controls to the RH side of the car. Make radio, console, glove box, RH door switch and courtesy lamp connections as necessary. See pages 7 and 9 for details.



1. Assemble the mounting bracket to the fuse-loaded fusebox and harness assembly using screws, washers and nuts "H, J and K" found in the 92972060 dash loose piece kit.



2. Using mounting template and instruction sheet 92972154, drill a new .125 mounting hole in the door hinge pillar area.



3. With the cluster assembly and all the original wiring removed, lay the assembled "bracket, fusebox and harness assembly" from step 1 across your steering column as shown above.

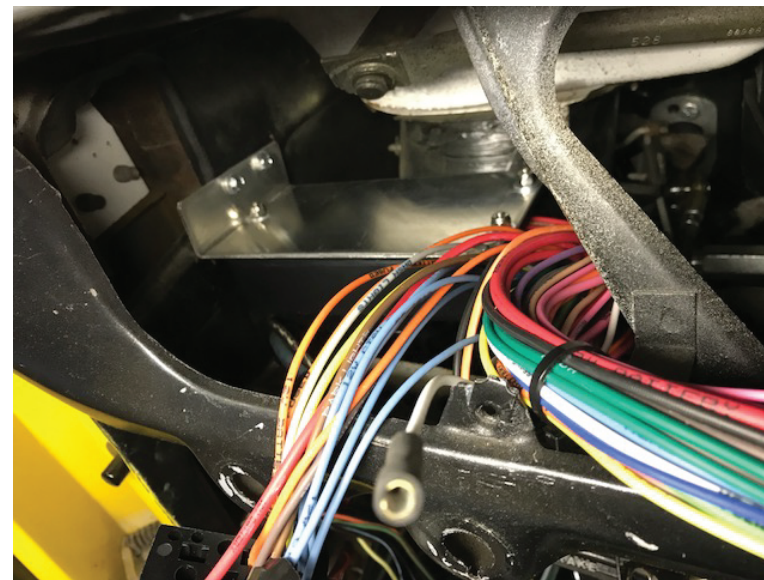

4. Tuck the "bracket, fusebox and harness assembly" down inside the dash opening, and using screws and washers "F and G" found in the 92972060 dash loose piece kit, attach the assembly to the LH door hinge pillar area. Carefully route the harness to avoid any sharp edges on the LH vertical dash support so that you do not cut or chaff any wires.



5. Install the two harness routing clips "N" into the original holes near the top of the two vertical dash supports as shown above.



6. Snap the main harness into the two new harness routing clips "N" so that the harness routes over the cluster opening area as shown above. After you plug your wiper harness into the white AAW "wiper feed" wire from page 6, you can snap that harness into the two mounting clips as well.



# Dash/Main harness installation instructions:

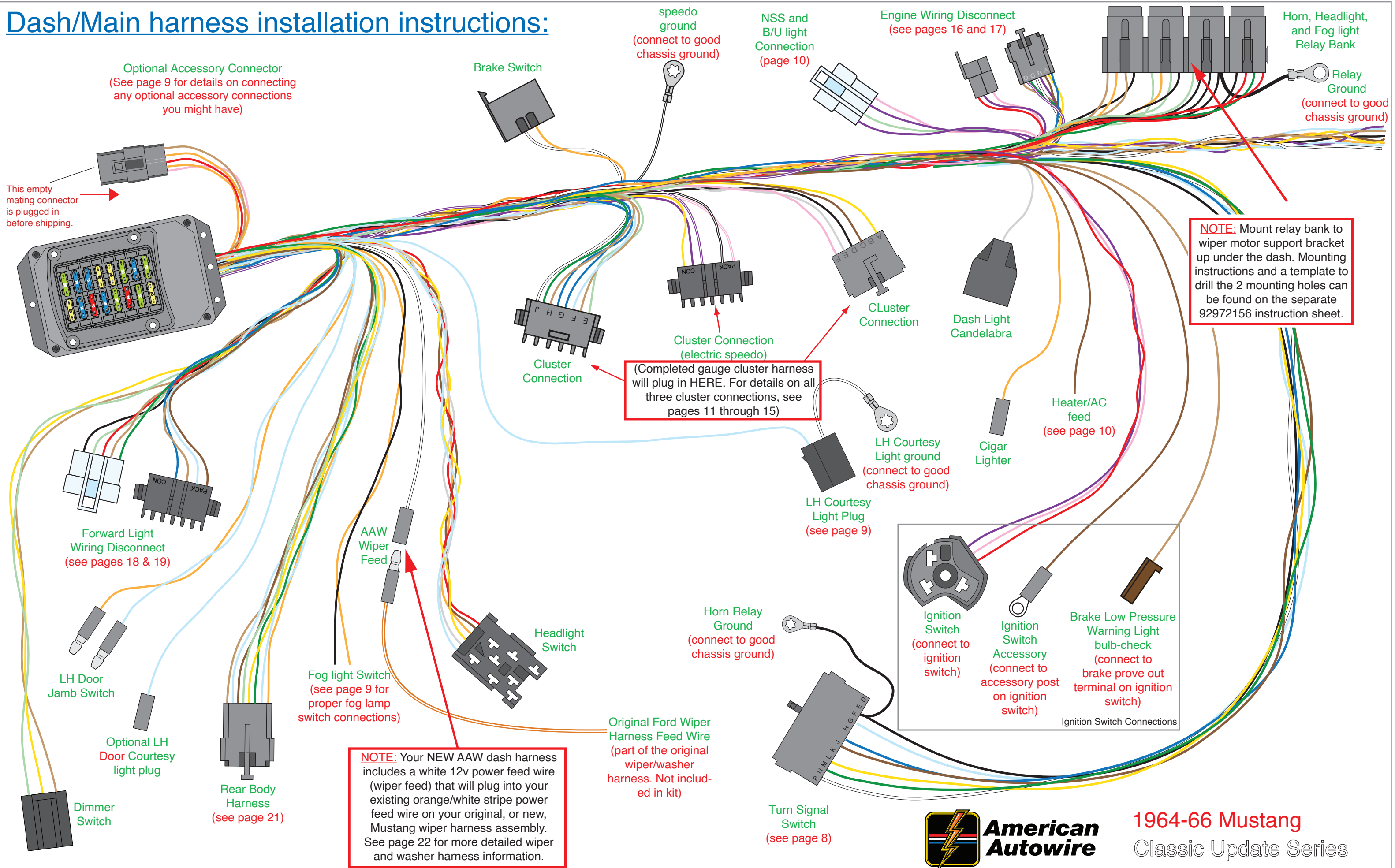

Optional Accessory Connector  
(See page 9 for details on connecting any optional accessory connections you might have)

This empty mating connector is plugged in before shipping.

(Completed gauge cluster harness will plug in HERE. For details on all three cluster connections, see pages 11 through 15)

**NOTE:** Mount relay bank to wiper motor support bracket up under the dash. Mounting instructions and a template to drill the 2 mounting holes can be found on the separate 92972156 instruction sheet.

**NOTE:** Your NEW AAW dash harness includes a white 12v power feed wire (wiper feed) that will plug into your existing orange/white stripe power feed wire on your original, or new, Mustang wiper harness assembly. See page 22 for more detailed wiper and washer harness information.

Original Ford Wiper Harness Feed Wire (part of the original wiper/washer harness. Not included in kit)

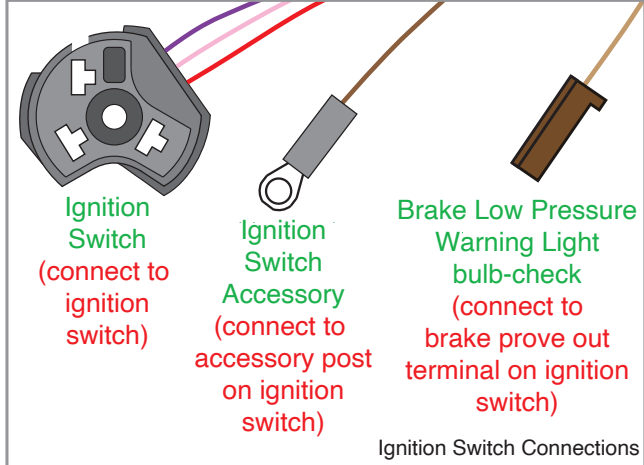

# Dash/Main harness installation instructions:

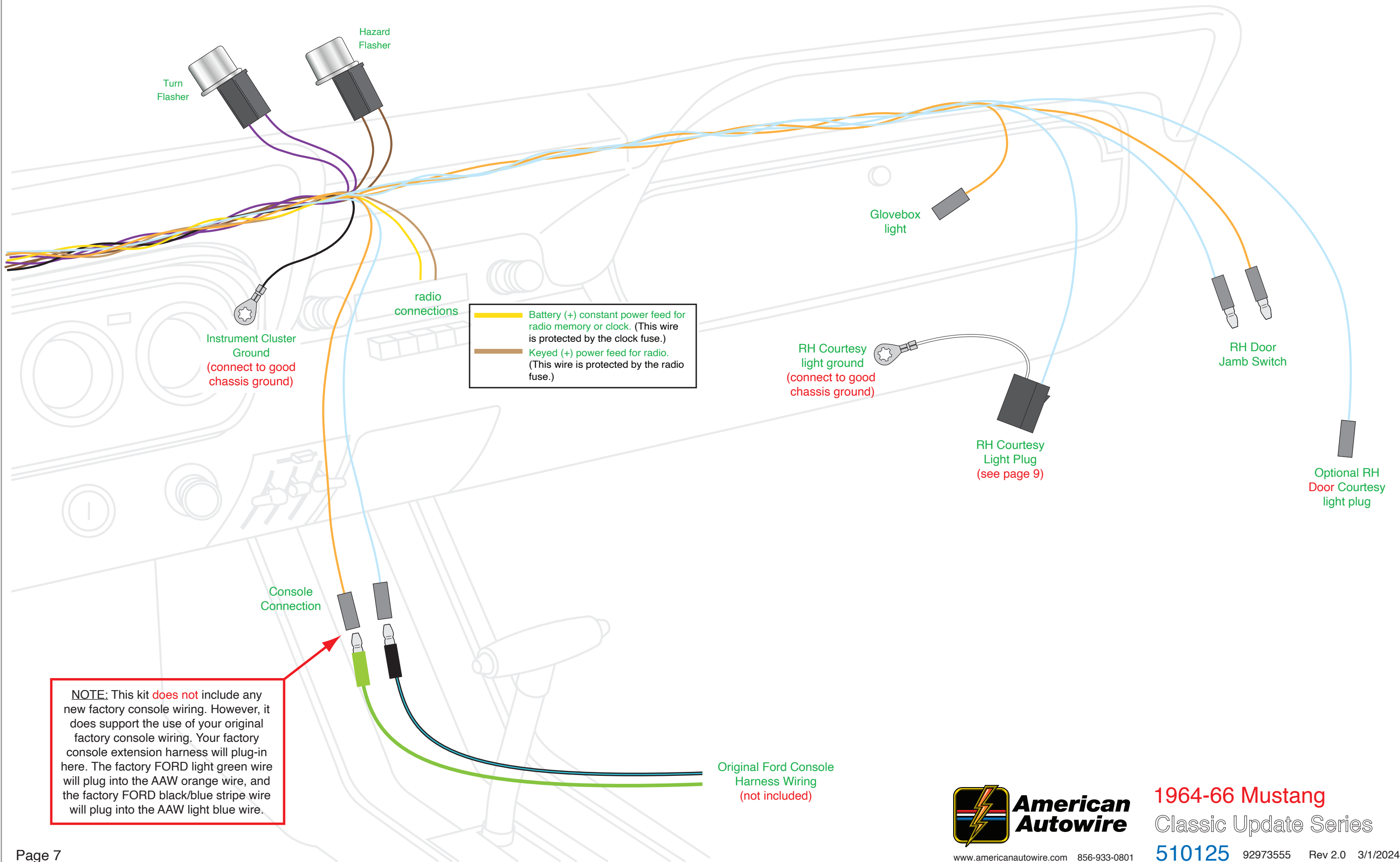

**NOTE:** This kit **does not** include any new factory console wiring. However, it does support the use of your original factory console wiring. Your factory console extension harness will plug-in here. The factory FORD light green wire will plug into the AAW orange wire, and the factory FORD black/blue stripe wire will plug into the AAW light blue wire.



www.americanautowire.com 856-933-0801

**1964-66 Mustang**  
Classic Update Series  
**510125** 92973555 Rev 2.0 3/1/2024

# Dash/Main harness installation instructions:

## AMERICAN AUTOWIRE DASH HARNESS CONNECTION

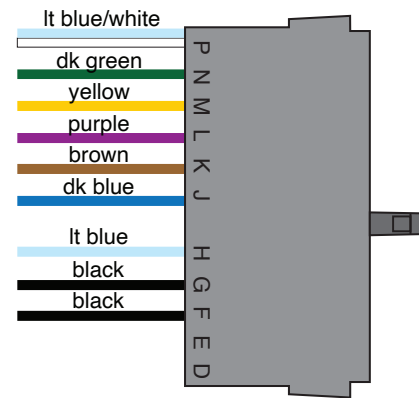

## ORIGINAL TURN SIGNAL SWITCH WIRING

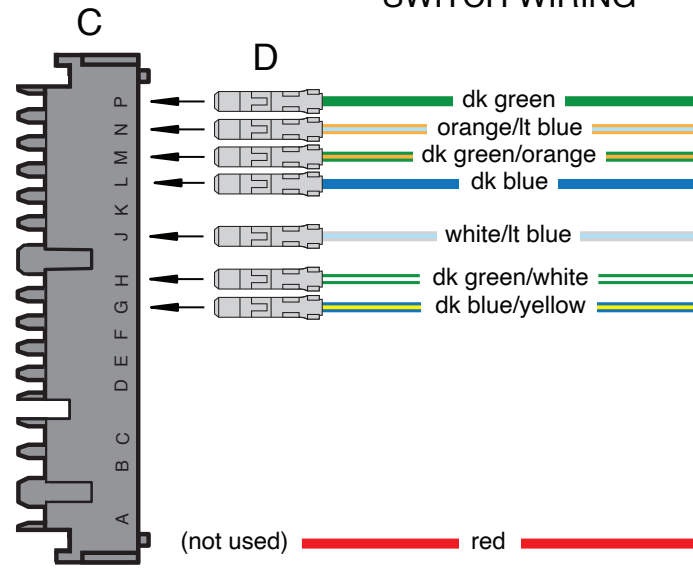

**DIAGRAM 'A' - AAW Turn Signal Switch Wires to Stock 1964 Steering Columns.**

**“Table A”**

AAW Wire Color	AAW Wire Function	AAW Connector Cavity	FORD Wire Color
Lt Blue/White	Third Brake Light/Brake SW	P	Dark Green
Dark Green	Right Rear Brake & Turn	N	Orange/Lt. Blue
Yellow	Left Rear Brake & Turn	M	Dk. Green/Orange
Purple	Turn Switch Feed	L	Dark Blue
Brown	Turn SW – Hazard	K	Not Used
Dark Blue	Right Front Turn	J	White/Lt. Bue
Light Blue	Left Front Turn	H	Dk. Green/White
Black	Horn Relay Ground	G	Dk. Blue/Yellow
Black	Horn Relay Ground	F	Not used for 64 application
None	None	E	
None	None	D	
None	None	A	Red - Not Used)

Remove the original Turn Signal Switch Connector and replace it with the AAW 14-way connector “C”. Crimp on terminal “D” to each of the original Turn Signal Switch wires and plug them into connector “C” (see Parts Kit 92973539). (NOTE: Some replacement turn signal switches have a red wire in them that will not be used in this application)

Use “Table A” above to align the wires. Also, for all of the 64 vehicles, the Steering Column Horn Button switches ground for the Horn Relay, which then switches power to the horns, exactly as original.

**“Table B”**

## AMERICAN AUTOWIRE DASH HARNESS CONNECTION

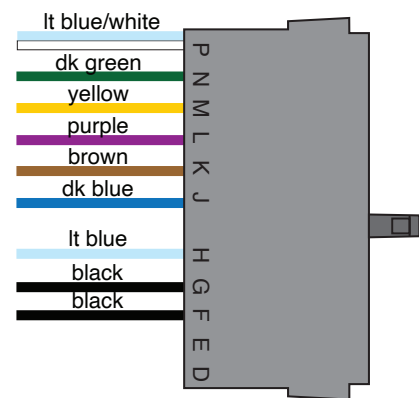

## ORIGINAL TURN SIGNAL SWITCH WIRING

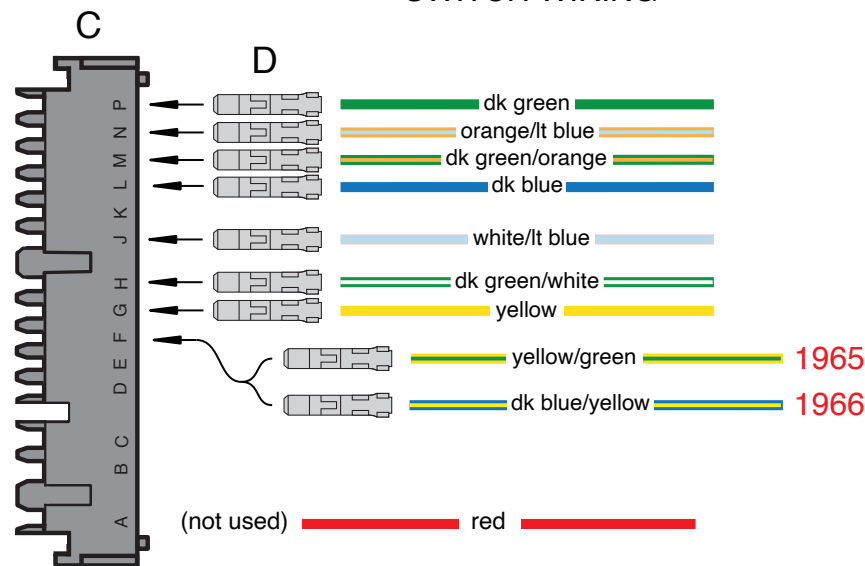

**DIAGRAM 'B' - AAW Turn Signal Switch Wires to Stock 1965-66 Steering Columns.**

AAW Wire Color	AAW Wire Function	AAW Connector Cavity	FORD Wire Color
Lt Blue/White	Third Brake Light/Brake SW	P	Dark Green
Dark Green	Right Rear Brake & Turn	N	Orange/Lt. Blue
Yellow	Left Rear Brake & Turn	M	Dk. Green/Orange
Purple	Turn Switch Feed	L	Dark Blue
Brown	Turn SW – Hazard	K	Not Used
Dark Blue	Right Front Turn	J	White/Lt. Blue
Light Blue	Left Front Turn	H	Dk. Green/White
Black	Horn Relay Ground	G	Yellow
Black	Horn Relay Ground	F	Yel./Green '65; Blue/Yel. '66
None	None	E	
None	None	D	
None	None	A	(Red - Not Used)

Remove the original Turn Signal Switch Connector and replace it with the AAW 14-way connector “C”. Crimp on terminal “D” to each of the original Turn Signal Switch wires and plug them into connector “C” (see Parts Kit 92973539). (NOTE: Some replacement turn signal switches have a red wire in them that will not be used in this application)

“Table B” above to align the wires. Also, for all of the '65-'66 vehicles, the Steering Column Horn Button switches ground for the Horn Relay, which then switches power to the Horns.





# Dash/Main harness installation instructions:

## Accessory connector wiring:

Use the provided 6-way empty connector, which is attached to the 6-way Accessory connector on the Dash Harness, and terminals "A" or "B" to add power wires (not included in kit) for the following optional systems:

Wire Color	Printing	Fuse #	Fuse Block Cover	Fuse rating	Description
Tan	FUEL PUMP	16	Fuel Pump	20A	Fused 12 volt IGNITION feed for fuel pump (may also be used to feed power to another ignition circuit).
Orange	POWER SEATS	3	Pwr Seats	30A	Fused 12 volt BATTERY feed for power seats (may also be used to feed power to another battery circuit).
Red	POWER LOCKS	5	Pwr Locks	20A	Fused 12 volt BATTERY feed for power door locks (may also be used to feed power to another battery circuit).
Pink	POWER WINDOWS	8	Pwr Window	30A	Fused 12 volt ACCESSORY feed for power windows (may also be used to feed power to another accessory circuit).
Orange	(No Printing)	1	Batt - Spare	30A	Fused 12 volt BATTERY feed (may also be used to feed power to a battery circuit).

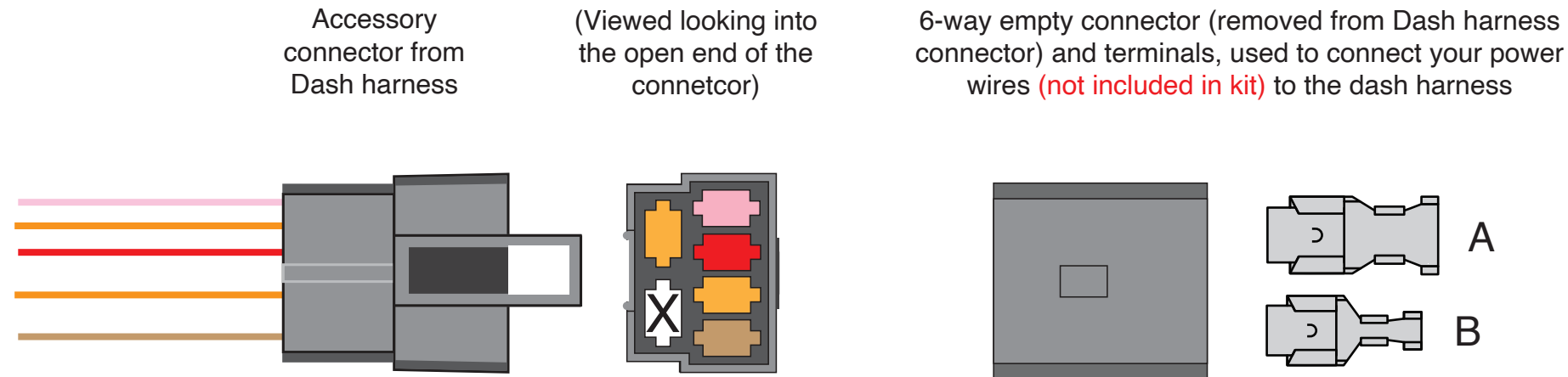

## Courtesy light wiring:

Connect the (2) courtesy light wiring extensions "FF" to the courtesy light plugs from the dash harness: The left-hand courtesy plug is at the same branch as the headlight switch, and will mount to the right of the steering column along the bottom of the dash. The right-hand courtesy plug is at the far end of the dash harness, near the glovebox lamp connection and RH door jamb switch connection, and will mount along the bottom of the dash. The (2) courtesy light wiring extensions are found in the dash loose piece bag, part number 92972061.

(2) courtesy light connections from Dash harness

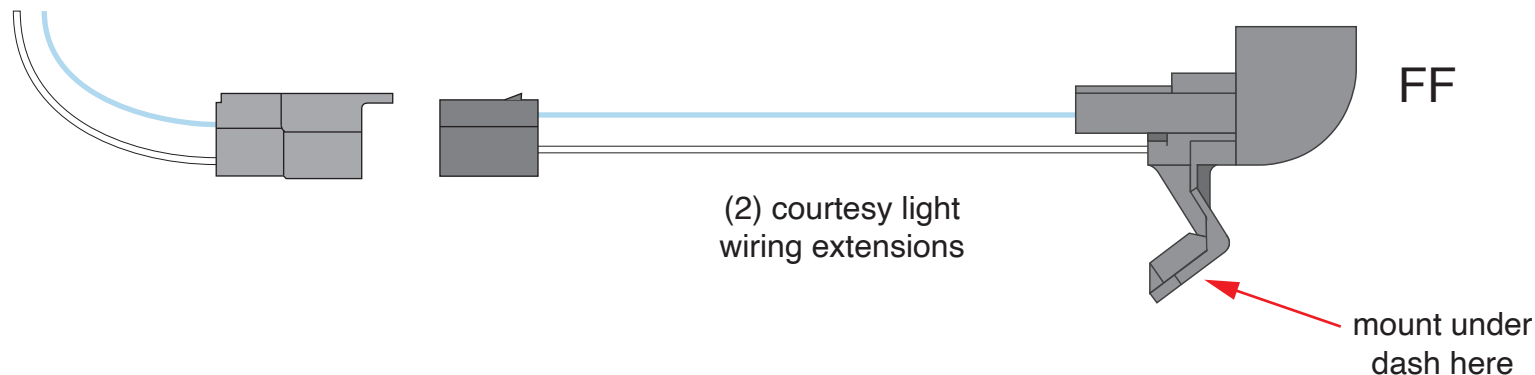

## Fog light switch wiring:

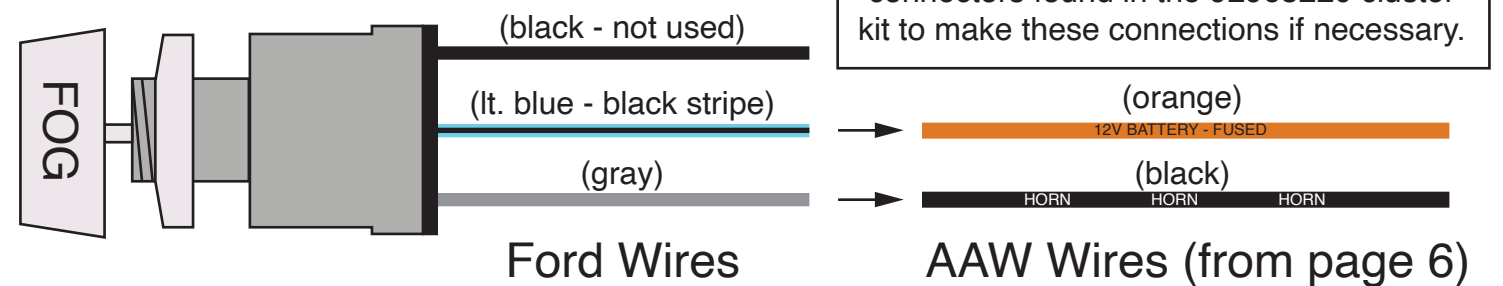

**NOTE:** You can use the blue butt-splice connectors found in the 92965220 cluster kit to make these connections if necessary.

**NOTE:** The factory Ford fog lamp switch utilized 3 wires: blue with a black stripe, gray, and black. For this application, the AAW orange wire will be connected to the original Ford blue with black stripe wire, and the AAW black wire will be connected to the original Ford gray wire. The original Ford black wire will not be used in this application and should be capped off.



**1964-66 Mustang**  
Classic Update Series  
**510125** 92973555 Rev 2.0 3/1/2024



# Dash/Main harness installation instructions:

## Neutral Safety Switch and Backup Switch wiring:

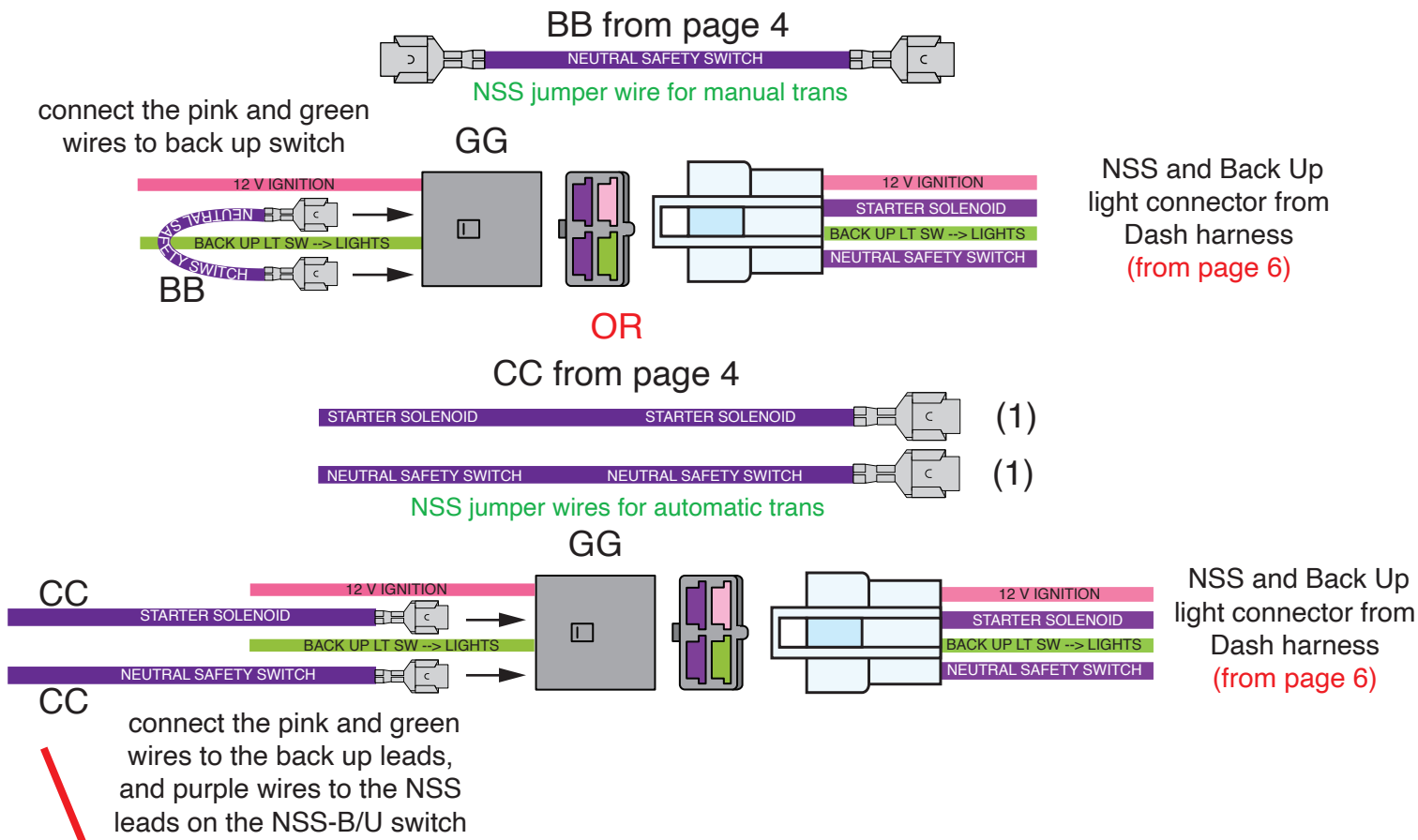

### Shown is a typical Ford NSS and Back Up Switch.

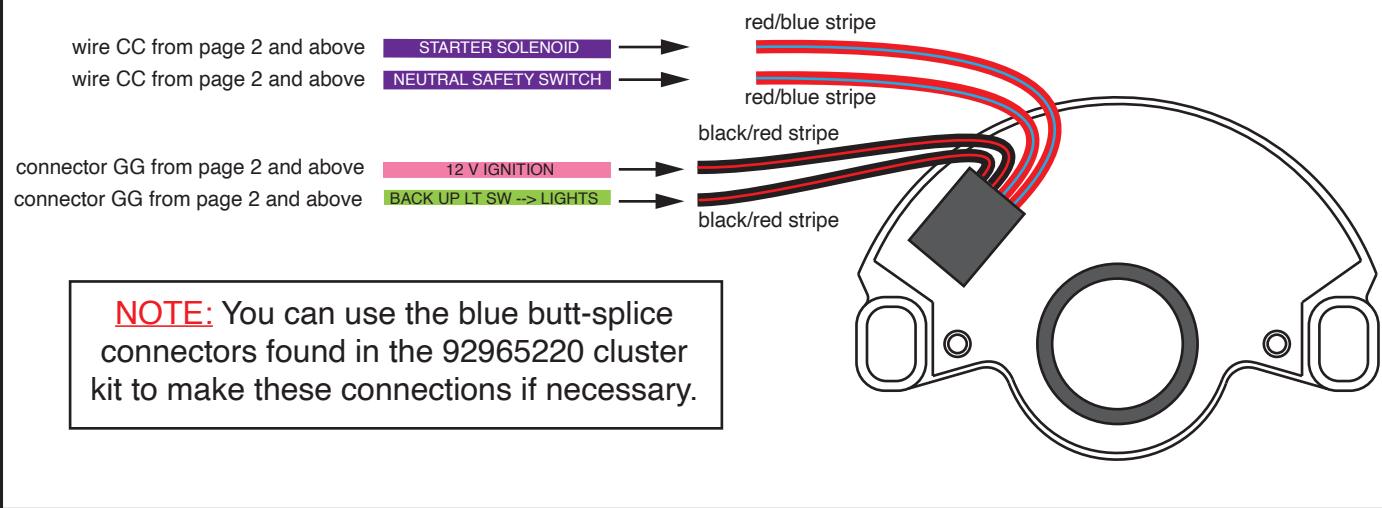

1964-66 Mustang  
Classic Update Series

510125 92973555 Rev 2.0 3/1/2024



www.americanautowire.com 856-933-0801

## Heater wiring:

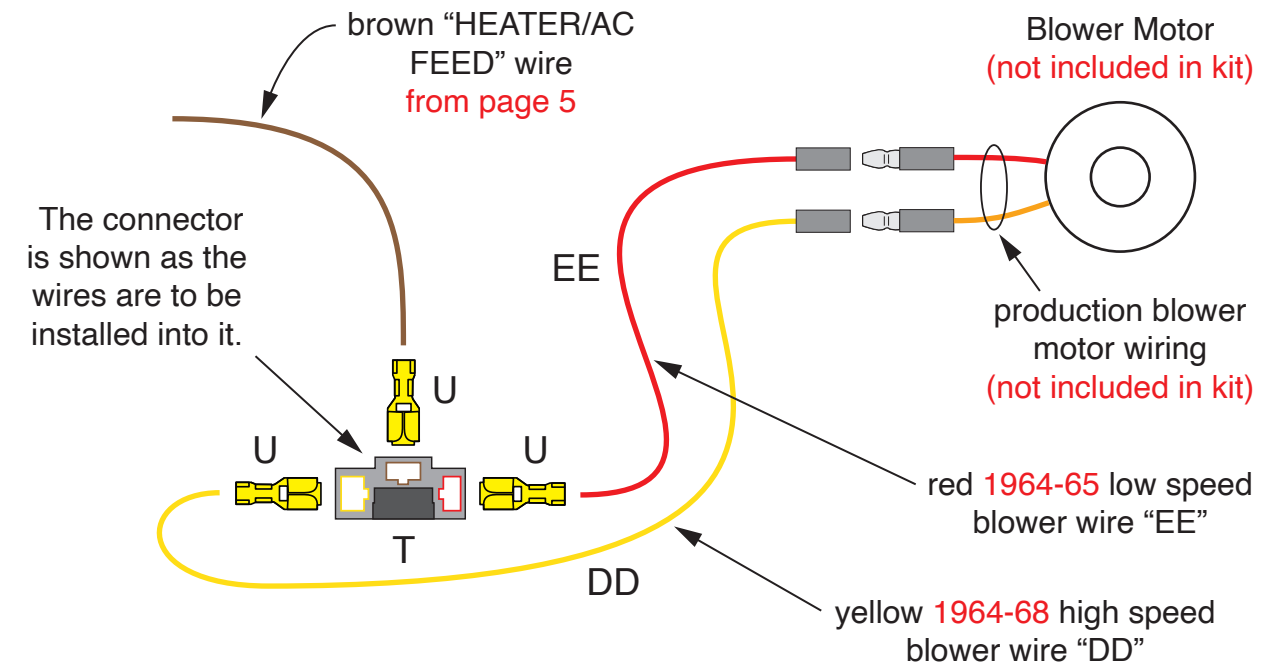



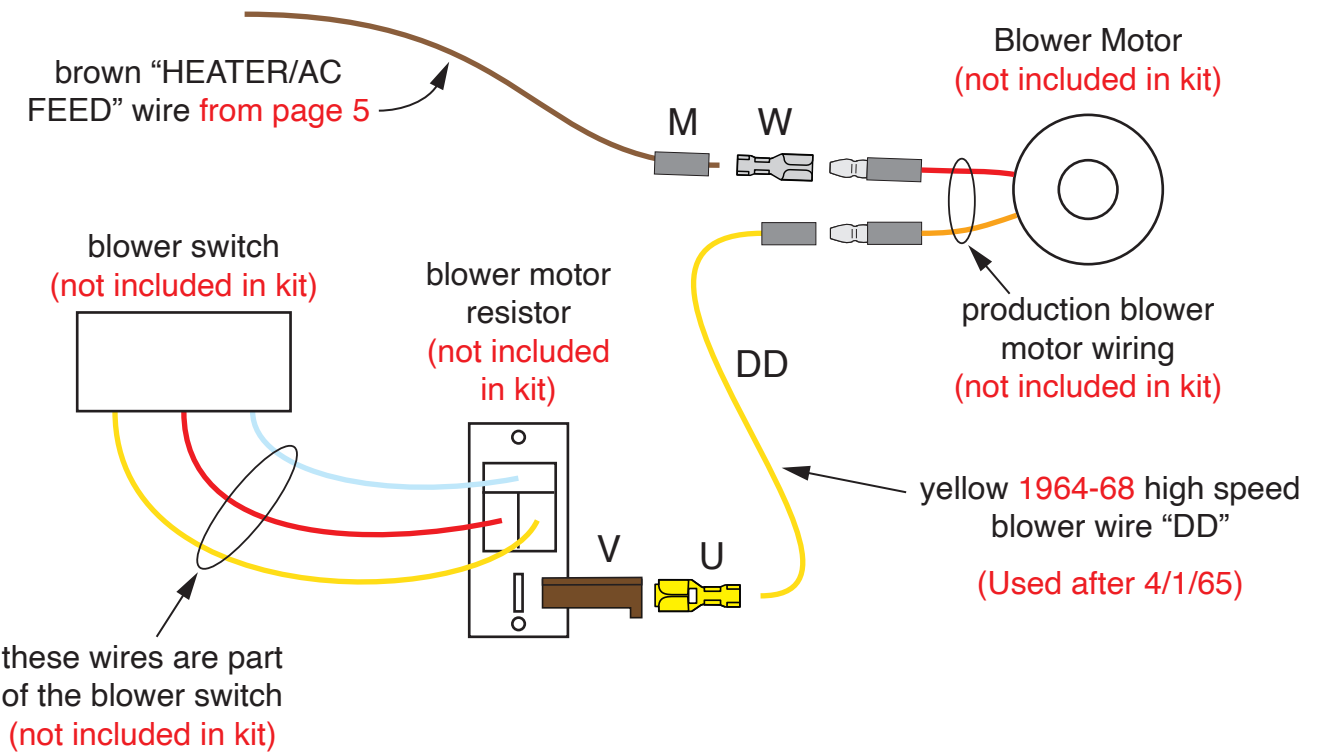



### '64 1/2 & early production '65, 2 speed Heater motor connections

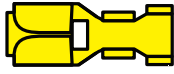
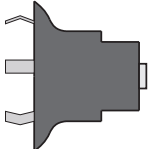
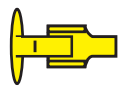
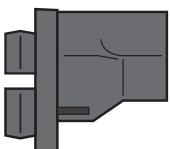
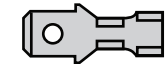

### '65 & '66, 3 Speed Heater motor connections with resistor

# Gauge Cluster harness installation instructions:

Shown below, are the supplied misc. terminals, plastic connector bodies, light sockets and hardware that will be used to complete your Gauge Cluster harness connections. They are itemized and referred to on this page, just as they are on the following pages of this Gauge Cluster instruction set.

- |   |   |  |   |   |   |
|---|---|--|---|---|---|
| A |    | (58 series single female conn, 1 pc.)  | G |    | (58 series double female terminal, 2 pcs.)      |
| B |    | (light socket, 10 pcs.)                | H |    | (terminal rivet, 15 pcs.)                       |
| C |   | (plastic light socket, 2 pcs.)         | J |    | (.25 male terminal, 2 pcs.)                     |
| D |  | (spring, plastic light socket, 3 pcs.) | K |  | (terminal, plastic light socket ground, 3 pcs.) |
| E |  | (rubber sleeve, 1 pc.)                 | L |  | (shrink tubing, 1 pc.)                          |
| F |  | (splice clip, 3 pcs.)                  |   |   |   |



**American Autowire**

www.americanautowire.com 856-933-0801

**1964-66 Mustang**  
 Classic Update Series  
**510125** 92973555 Rev 2.0 3/1/2024

## How to install light sockets and light socket terminals.

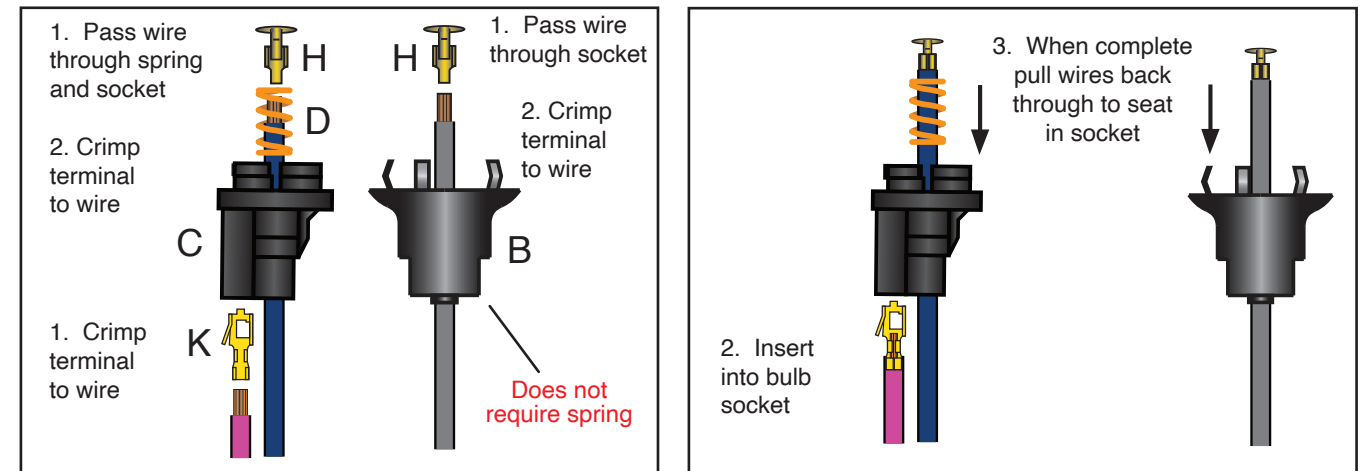

## How to use the splice clip to join multiple wires.

Below is just an **EXAMPLE** of how to use the splice clip and shrink tubing; see your specific application on the following pages for actual splice information.

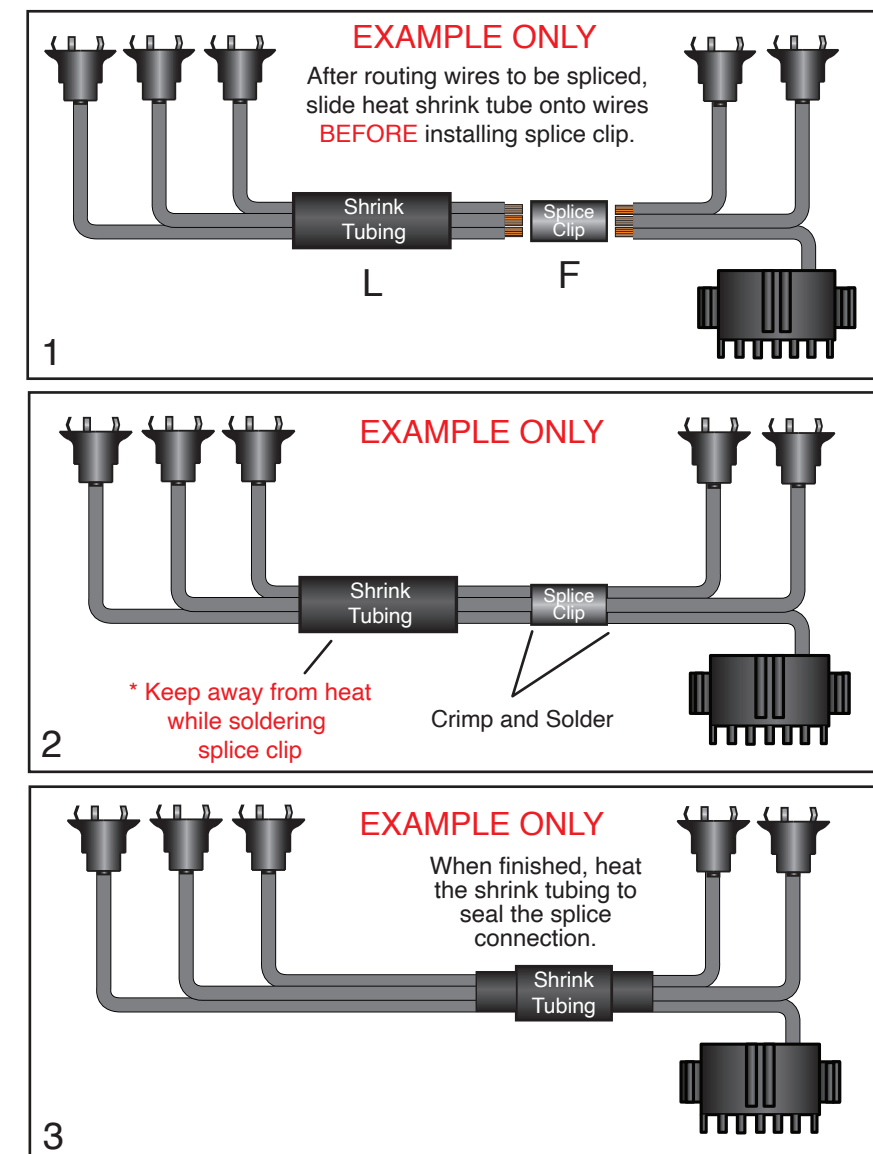

# Gauge Cluster harness (aftermarket gauges) installation instructions:

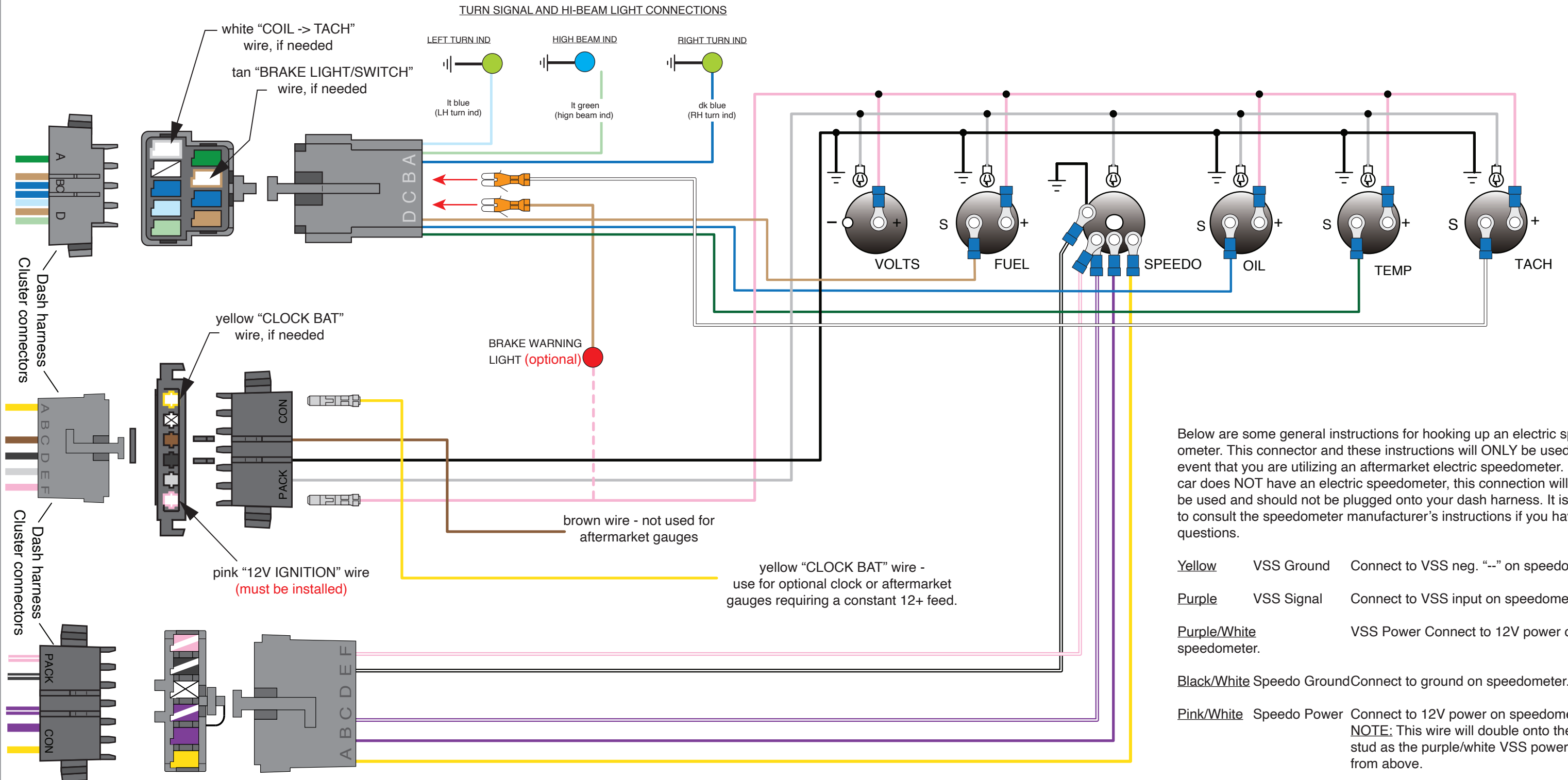

See pages 13-15 for stock dash cluster applications



# Gauge Cluster harness installation instructions:

1964 1/2 & 1965 Mustang with fuel and temp gauge, oil and gen lights & generator

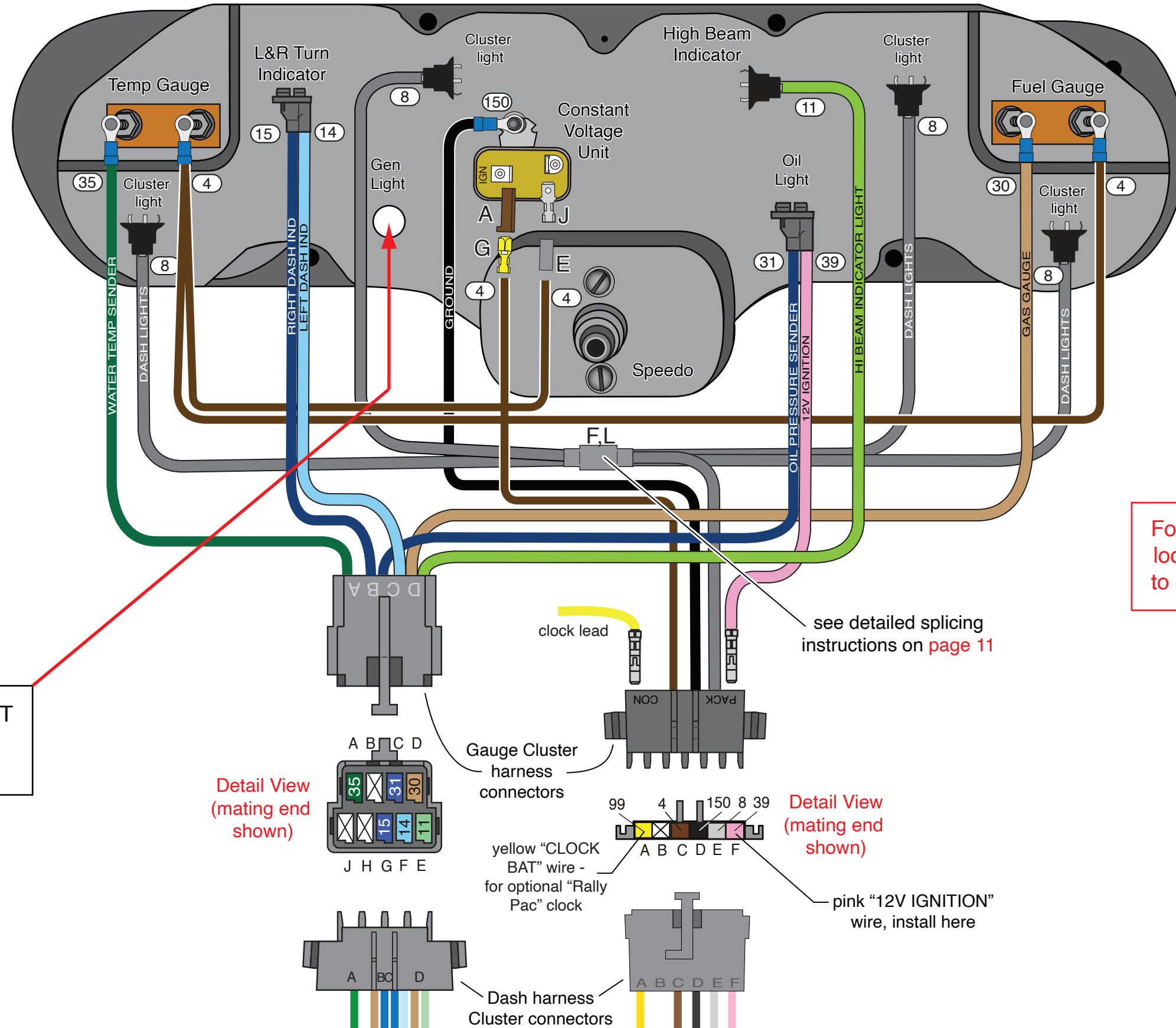

For proper wire locations, refer to "Detail View"

GEN. LIGHT NOT SUPPORTED IN THIS KIT

see detailed splicing instructions on page 11

Detail View (mating end shown)

Detail View (mating end shown)

yellow "CLOCK BAT" wire - for optional "Rally Pac" clock

pink "12V IGNITION" wire, install here



www.americanautowire.com 856-933-0801

1964-66 Mustang  
Classic Update Series  
510125 92973555 Rev 2.0 3/1/2024



# Gauge Cluster harness installation instructions:

1965 Mustang with fuel and temp gauge, oil and gen lights & alternator

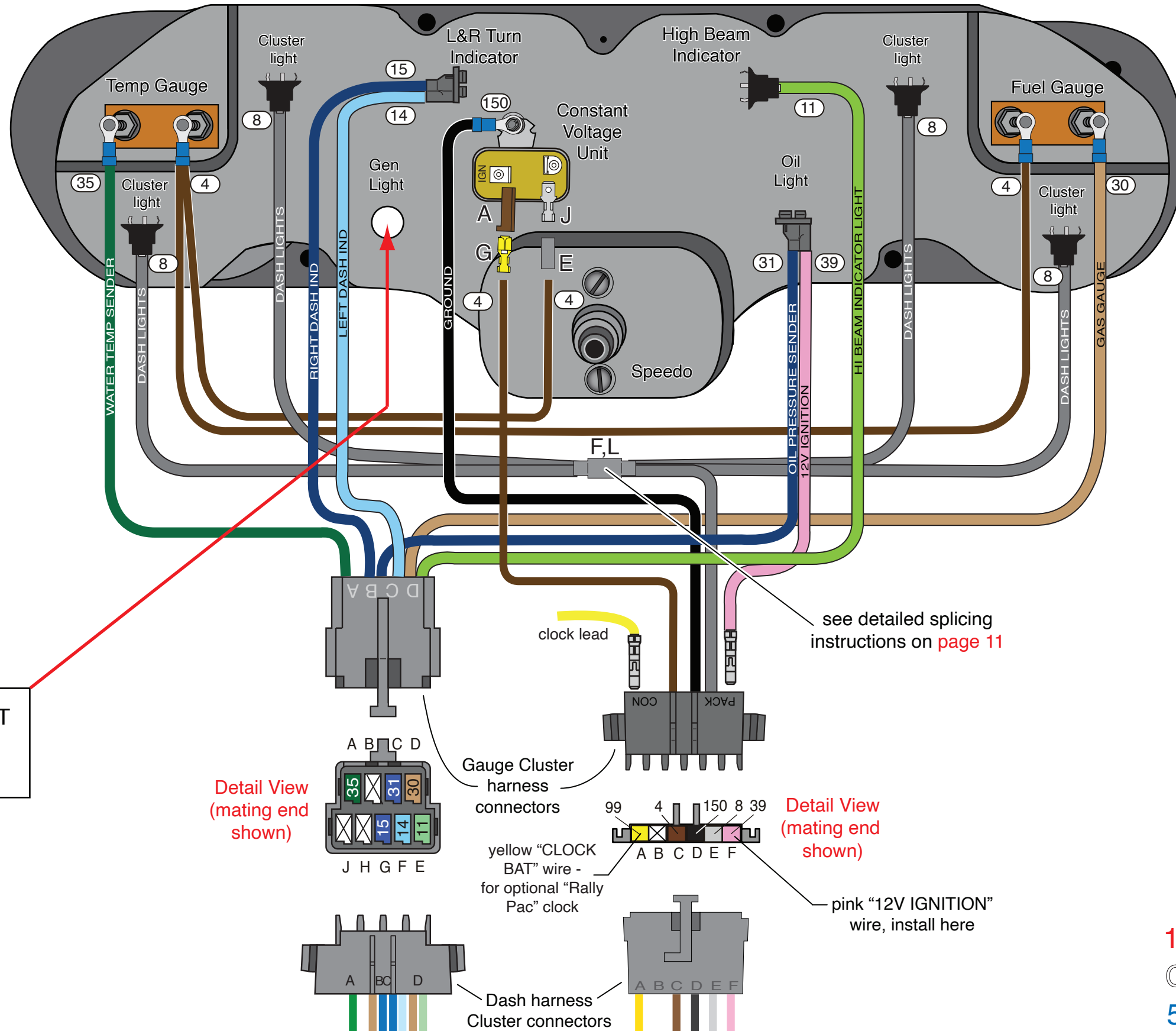

GEN. LIGHT NOT SUPPORTED IN THIS KIT

For proper wire locations, refer to "Detail View"



www.americanautowire.com 856-933-0801

1964-66 Mustang  
Classic Update Series

510125 92973555 Rev 2.0 3/1/2024

# Gauge Cluster harness installation instructions:

1965 Mustang with factory gauges; 1966 Mustang all

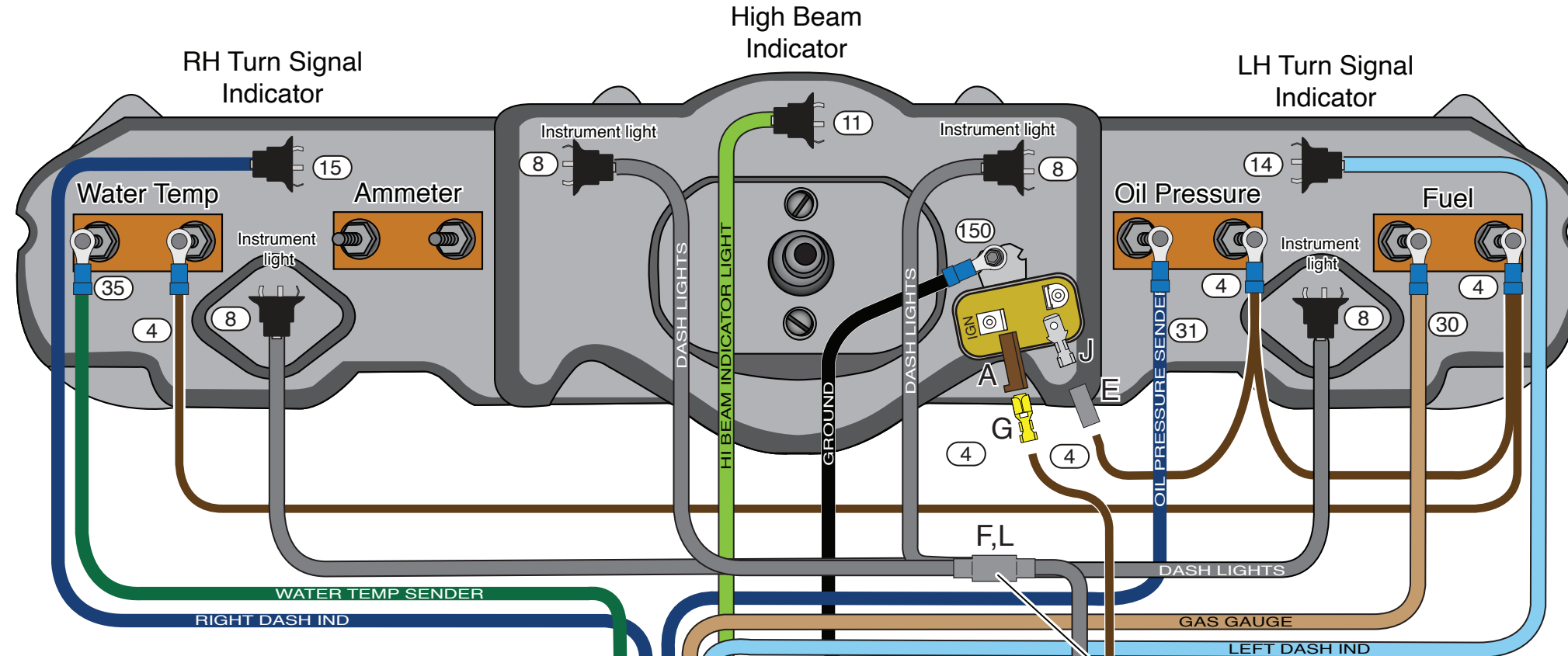

AMMETER NOT SUPPORTED IN THIS KIT

For proper wire locations, refer to "Detail View"

see detailed splicing instructions on page 11

Detail View (mating end shown)

Detail View (mating end shown)

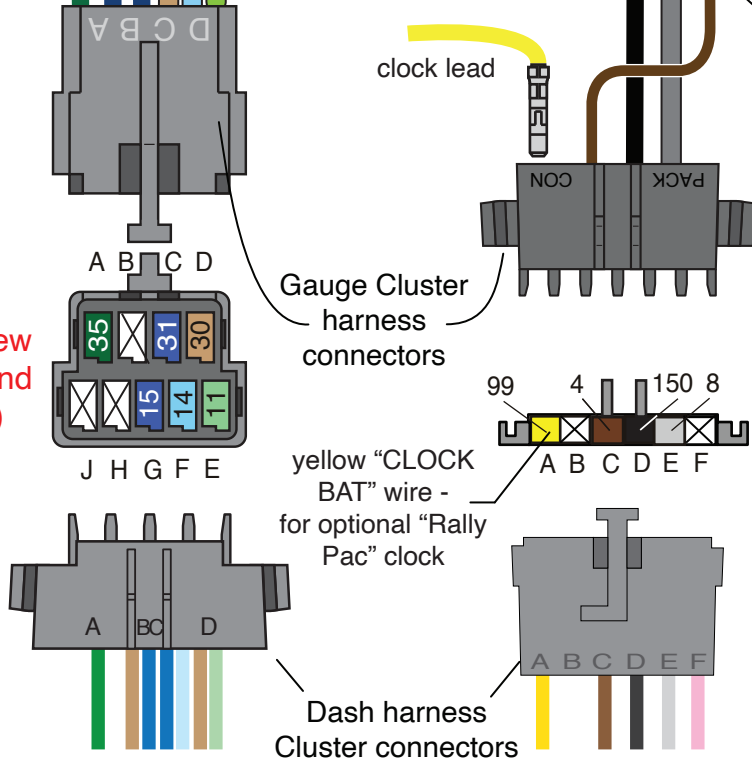





www.americanautowire.com 856-933-0801

1964-66 Mustang Classic Update Series

510125 92973555 Rev 2.0 3/1/2024

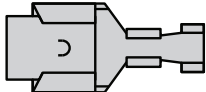
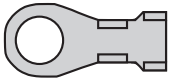
## Engine harness installation instructions:

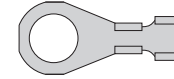
Shown below, are the supplied misc. terminals, sleeves, plastic connector bodies and wires, included in the Engine Harness and Loose Piece bags, that will be used to complete your Engine harness connections. They are itemized and referred to on this page, just as they are on the following pages of this Engine instruction set.

- A  (56 Series single female connector, 2 pcs)
- B  (56 Series single female terminal, 4 pcs)
- C  (ring terminal, 3 pcs)
- D  (large rubber sleeve, 2 pcs)
- E  (ring terminal, 4 pcs)
- F  (small rubber sleeve, 2 pcs)

## Engine harness Connections:

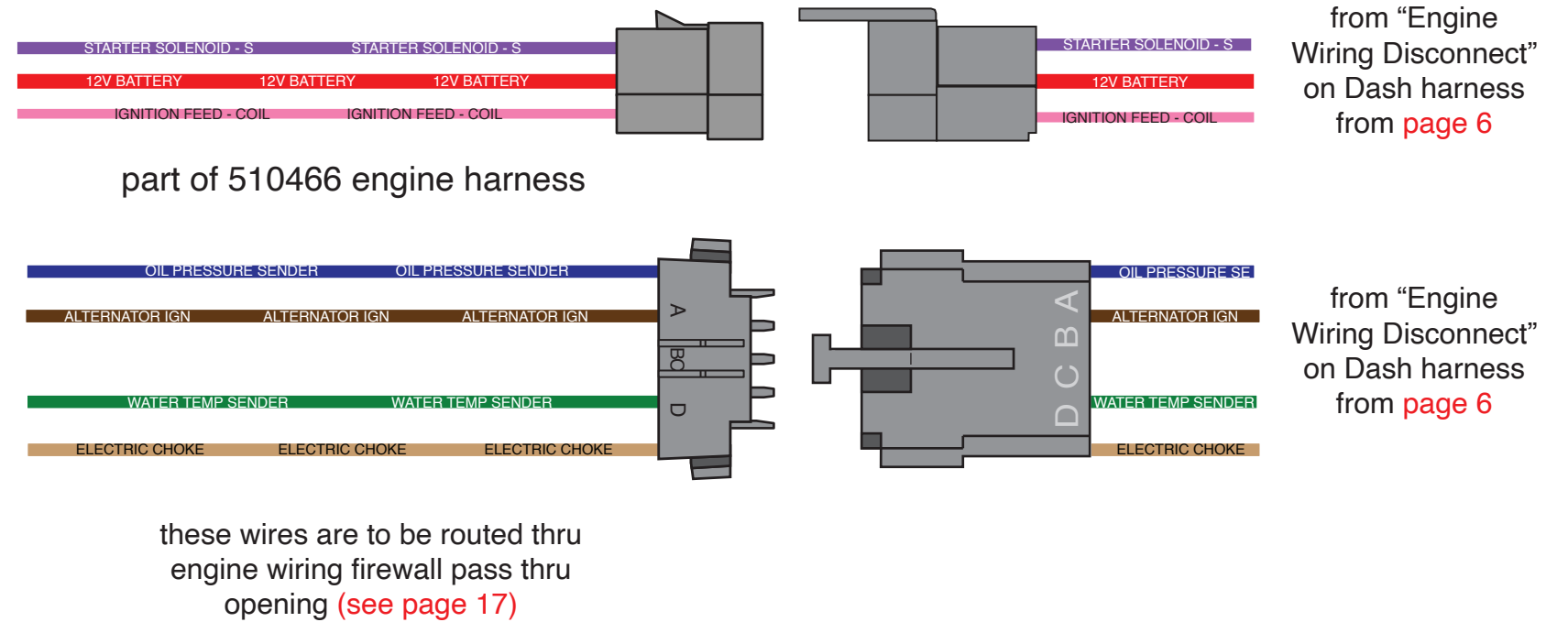

## Vehicle Speed Sensor and Tach wiring:

route these wires (along with the other Engine harness wires) thru the engine wiring, firewall pass thru opening (see page 17)

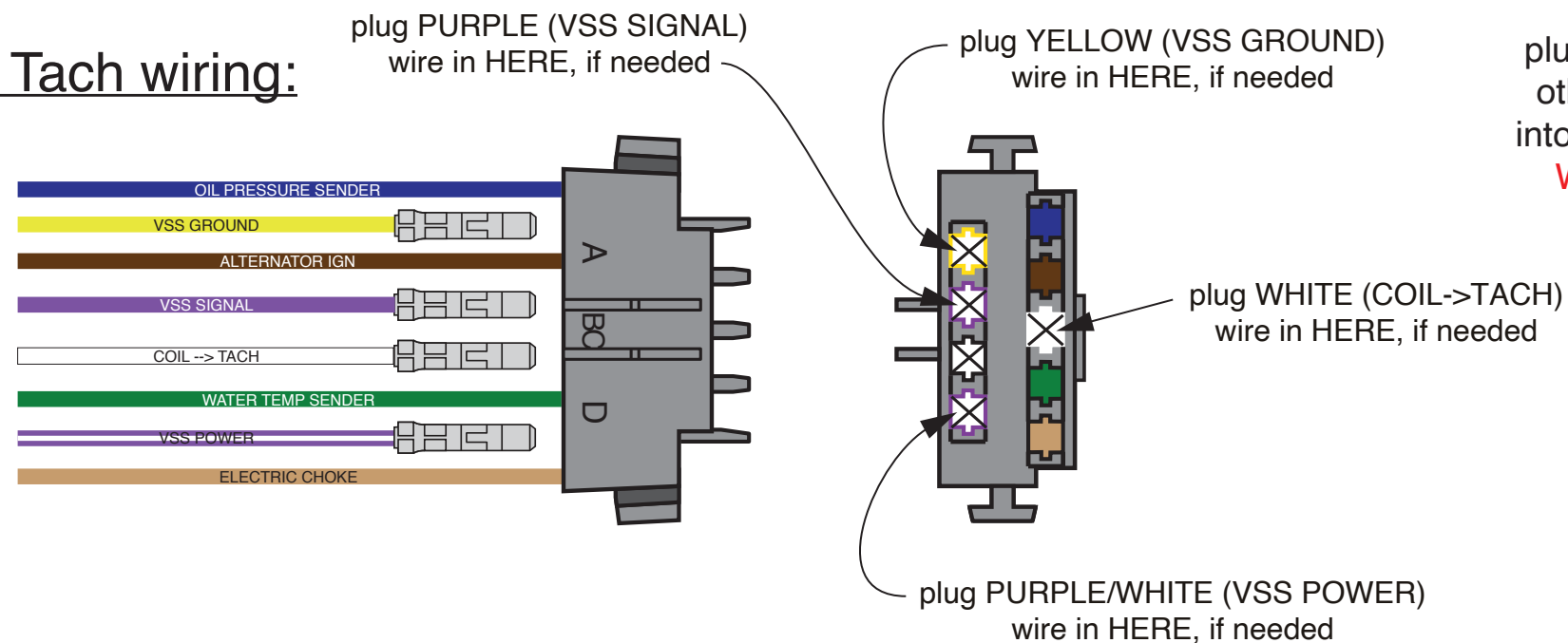

plug this connector (along with the other Engine harness connector) into the Dash harness (see "Engine Wiring Disconnect" on page 6)



www.americanautowire.com 856-933-0801

1964-66 Mustang  
Classic Update Series  
510125 92973555 Rev 2.0 3/1/2024

# Engine harness installation instructions:

Install grommet (see item "P" on page 4 of Dash harness loose piece kit) into the firewall pass thru opening, then pass the engine wiring thru the grommet (not including relay blocks). After wires are passed thru, apply silicone sealer to this area to make a weather-tight seal

1964-66 Mustang  
 Classic Update Series  
 510125 92973555 Rev 2.0 3/1/2024



www.americanautowire.com 856-933-0801

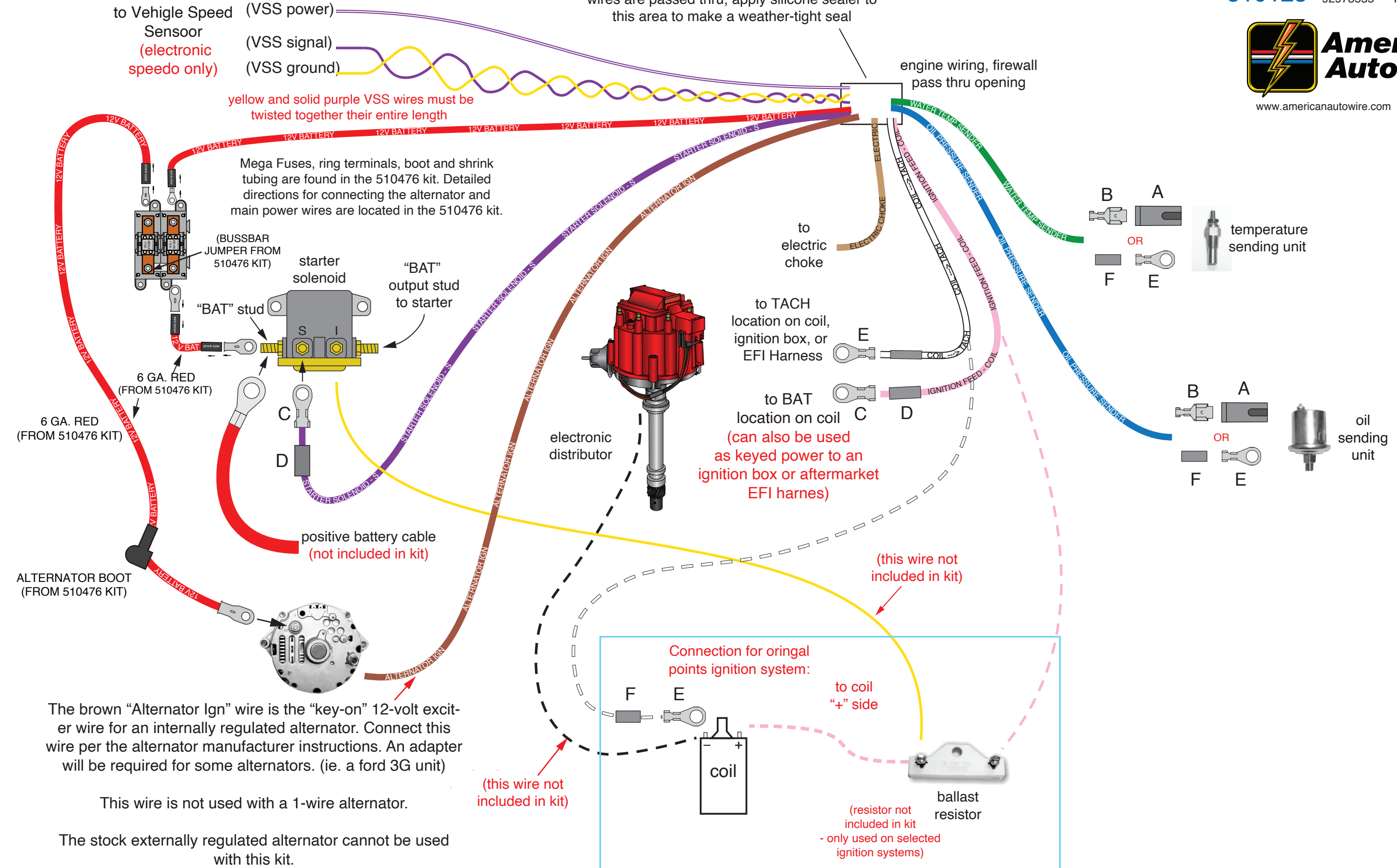

The brown "Alternator Ign" wire is the "key-on" 12-volt exciter wire for an internally regulated alternator. Connect this wire per the alternator manufacturer instructions. An adapter will be required for some alternators. (ie. a ford 3G unit)

This wire is not used with a 1-wire alternator.

The stock externally regulated alternator cannot be used with this kit.



# Front Light harness installation instructions:

Shown below, are the supplied misc. terminals, plastic connector bodies, and pigtails, included in the Front Light Harness and Loose Piece bags, that will be used to complete your Front Light harness connections. They are itemized and referred to on this page, just as they are on the following pages of this Front Light instruction set.

**A**  (56 Series double female connector, 2 pcs)

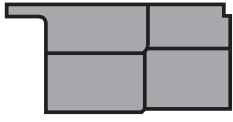
**B**  (56 Series double male connector, 2 pcs)

**C**  (56 Series single female connector, 2 pcs)

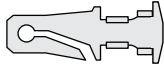
**D**  (56 Series single male terminal, 5 pcs)

**E**  (56 Series double male terminal, 3 pcs)

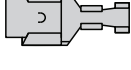
**F**  (56 Series single female terminal, 7 pcs)

**G**  (59 Series double female terminal, 4 pcs)

**H**  (59 Series single female terminal, 4 pcs)

**J**  (56 Series single female connector, 1 pc)

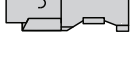
**K**  (56 Series double female terminal, 2 pcs)

**L**  (BCAT assy - Brake pressure differential warning switch, 1 pc)

**M**  (67-68 hood mounted directional lights pigtail [not used on 64-66], 1 pc)

**N**  (headlight connector assy, 2 pcs)

### Front light harness (and 1967-68 hood mounted directional light wiring only):

to 67-68 hood mounted directional lights (not used on 64-66)

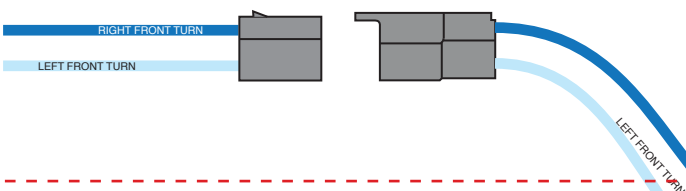

from "Forward Light Wiring Disconnect" on Dash harness from [page 6](#)

part of 510465 front light harness

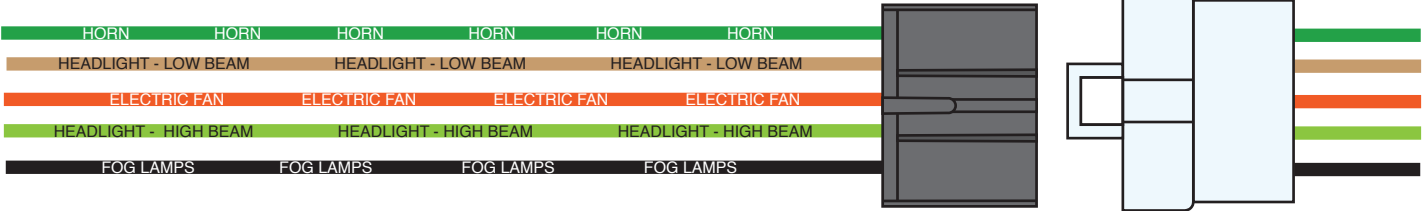

from "Forward Light Wiring Disconnect" on Dash harness from [page 6](#)

these wires are to be routed thru forward lamp wiring firewall pass thru opening (see [page 19](#))



www.americanautowire.com 856-933-0801

**1964-66 Mustang**  
 Classic Update Series  
**510125** 92973555 Rev 2.0 3/1/2024

# Front Light harness installation instructions:



www.americanautowire.com 856-933-0801

1964-66 Mustang  
Classic Update Series  
510125 92973555 Rev 2.0 3/1/2024

This plug under the dash from Front Light harness is for 67-68 hood mounted directional lights. (not used on 64-66)

firewall pass thru opening for forward lamp, electric fan, horn and brake switch warning wiring.

Install grommet (see item "P" on page 4 of Dash harness loose piece kit) into the firewall pass thru opening, then pass the forward wiring thru the grommet (not including relay blocks). After wires are passed thru, apply silicone sealer to this area to make a weather-tight seal.

to brake pressure sending unit (if needed)

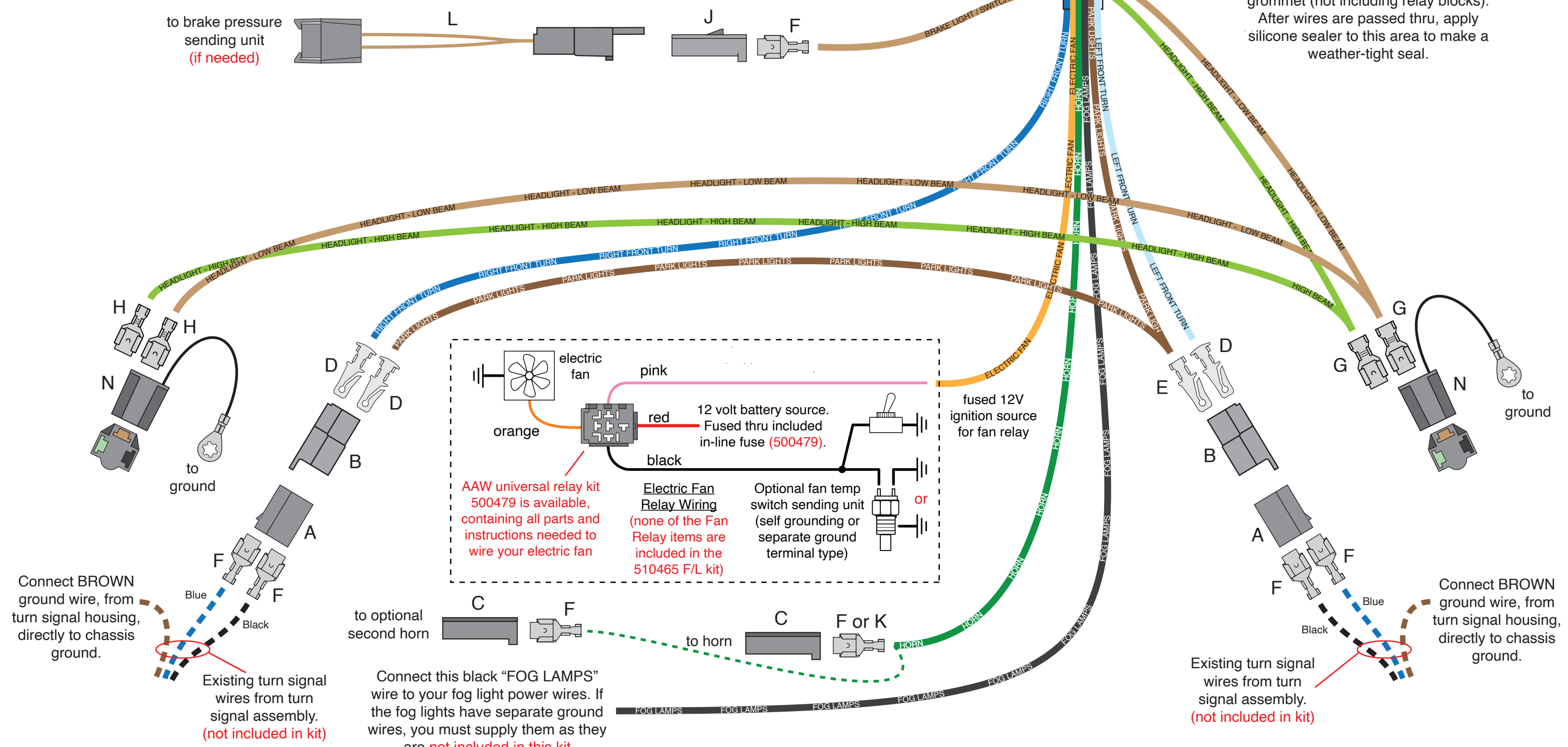
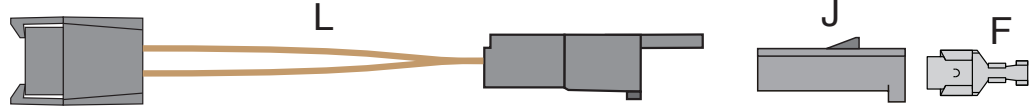

Connect BROWN ground wire, from turn signal housing, directly to chassis ground.

Existing turn signal wires from turn signal assembly. (not included in kit)

Connect this black "FOG LAMPS" wire to your fog light power wires. If the fog lights have separate ground wires, you must supply them as they are not included in this kit

Existing turn signal wires from turn signal assembly. (not included in kit)

Connect BROWN ground wire, from turn signal housing, directly to chassis ground.

## Rear Body harness installation instructions:

Shown below, are the supplied misc. terminals, plastic connector bodies, clamps and wire extensions, included in the Rear Body Harness and Loose Piece bags, that will be used to complete your Rear Body harness connections. They are itemized and referred to on this page, just as they are on the following pages of this Rear Body instruction set.

A  (56 Series single female terminal, 6 pcs)

B  (56 Series double female connector, 2 pcs)

C  (56 Series single male connector, 2 pcs)

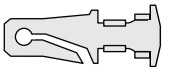
D  (56 Series single male terminal, 8 pcs)

E  (56 Series double female terminal, 3 pcs)

F  (56 Series single female connector, 2 pcs)

G  (single female terminal, 7 pcs)

H  (male bullet terminal, 3 pcs)

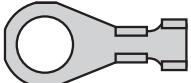
J  (ring terminal, 2 pcs)

K  (large rubber sleeve, 5 pcs)

L  (small rubber sleeve, 2 pcs)

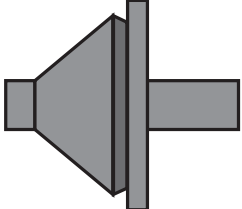
M  (rubber grommet, 1 pc)

N  (56 Series double male connector, 2 pcs)

P  (left tail light extension, 1 pc)  
 Wires on actual mold-on connector, may be in either position; either way is acceptable.

R  (right tail light extension, 1 pc)

T  (12V CTSY SW wire, 1 pc)

U  (12V CTSY SW wire, 1 pc)

V  (THIRD BRAKE LIGHT wire, 1 pc)

W  (12V BATTERY-FUSED wire, 1 pc)

Y  (CTS Y GROUND wire, 2 pcs)



www.americanautowire.com 856-933-0801

**1964-66 Mustang**  
 Classic Update Series  
**510125** 92973555 Rev 2.0 3/1/2024



# Rear Body harness installation instructions:

1964-66 Mustang  
Classic Update Series  
510125 92973555 Rev 2.0 3/1/2024



www.americanautowire.com 856-933-0801

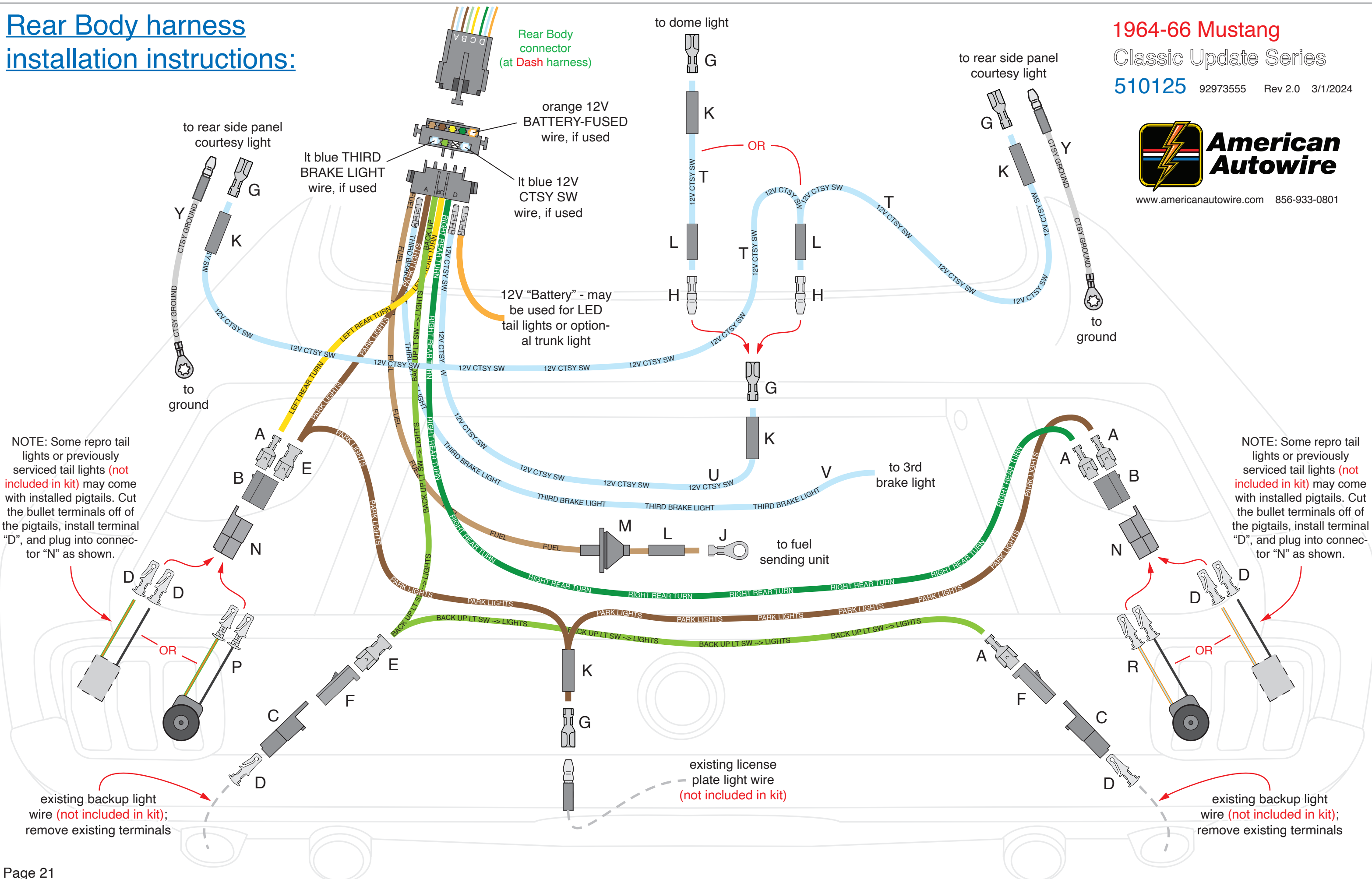

NOTE: Some repro tail lights or previously serviced tail lights (not included in kit) may come with installed pigtails. Cut the bullet terminals off of the pigtails, install terminal "D", and plug into connector "N" as shown.

NOTE: Some repro tail lights or previously serviced tail lights (not included in kit) may come with installed pigtails. Cut the bullet terminals off of the pigtails, install terminal "D", and plug into connector "N" as shown.

existing backup light wire (not included in kit); remove existing terminals

existing license plate light wire (not included in kit)

existing backup light wire (not included in kit); remove existing terminals

**1965-6 SINGLE SPEED**

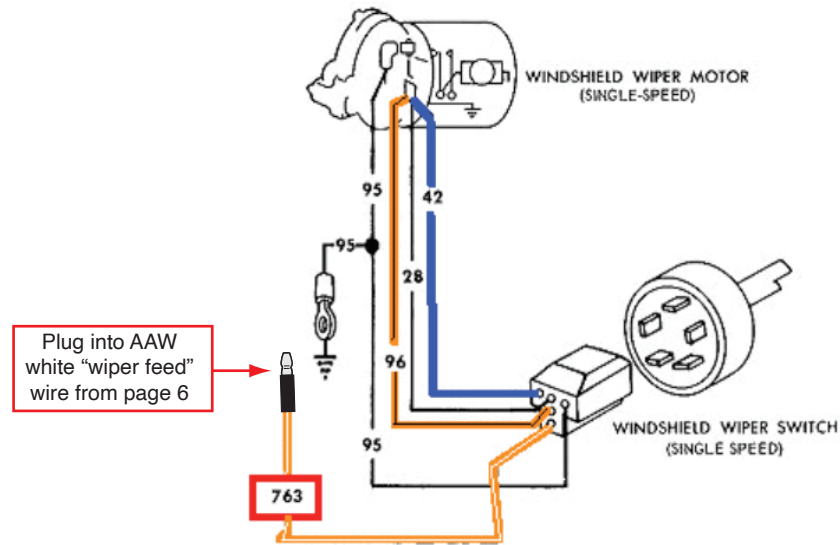

- 19 BLUE-RED
- 61 21 YELLOW
- 25 BLACK-ORANGE
- 234 57 28 BLACK
- 29 YELLOW-WHITE
- 297 30 BLACK-GREEN
- 31 WHITE-RED
- 37 BLACK-YELLOW
- 39 RED-WHITE
- 56 42 BLUE
- 53 BLACK-BLUE
- 54 GREEN-YELLOW
- 95 58 WHITE
- 63 RED
- 65 GREEN
- 96 ORANGE-BLACK
- 763 ORANGE-WHITE**
- 941 BLACK-WHITE

**1964-6 TWO SPEED WITH WASHER**

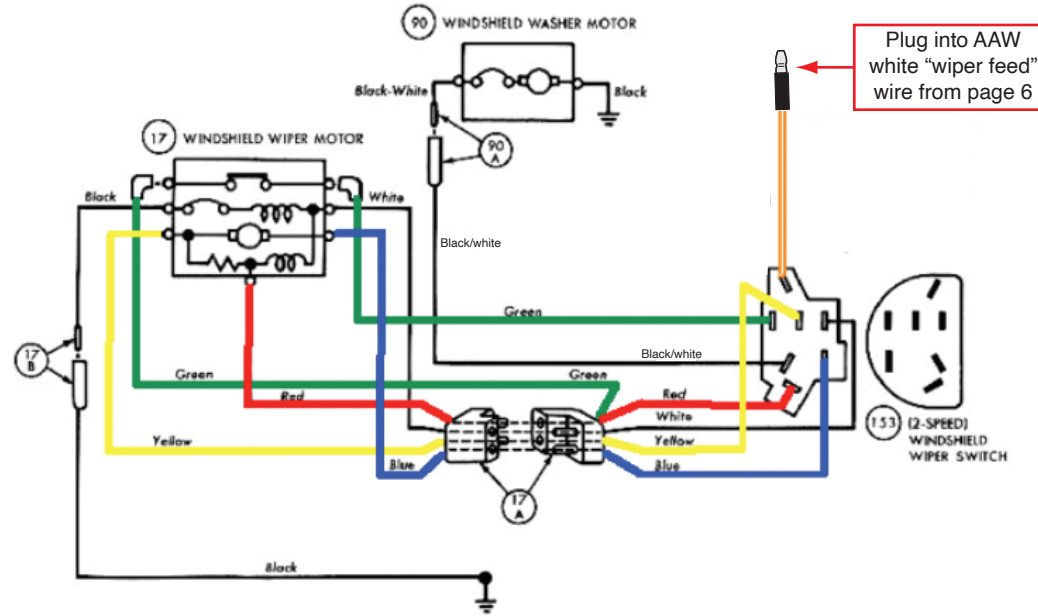

**WIPER HARNESS DETAILS:**

**NOTE 1:** For the 1966 2 speed with washer application, there was a second wire going out to the pump that is not shown at the left. That wire was black in color, and was a ground wire.

**NOTE 2:** This new AAW kit **DOES NOT** include any wiper or washer harnesses, only the 12v power feed to connect them to. That white "wiper feed" wire can be found on page 6 of this instruction set.

There are three different wiper switch/motor configurations that were used from 1964 through 1966. Your NEW AAW dash harness includes a white 12v power feed wire ("wiper feed" as found on page 6) that will plug into the existing orange/white stripe power feed wire on your original, or new, Mustang wiper harness assembly. New wiper wire harnesses are available from most Mustang parts suppliers if your original is not in good condition.

**Fuse Label, Values and Locations**

Batt - Spare 30A - BAT	1	9	Wiper 20A - ACC
Clock/Radio 15A - BAT	2	10	Heat/AC 30A - ACC
Power Seat 30A - BAT	3	11	Radio 10A - ACC
Cigar - Lighter 20A - BAT	4	12	Engine Fan 30A - ACC
Power Locks 20A - BAT	5	13	Turn 15A - IGN
Stop/Courtesy 15A - BAT	6	14	Gauges, B/U 10A - IGN
Hazard 15A - BAT	7	15	Elec. Choke 15A - IGN
Pwr. Window 30A - IGN	8	16	Fuel Pump 20A - IGN

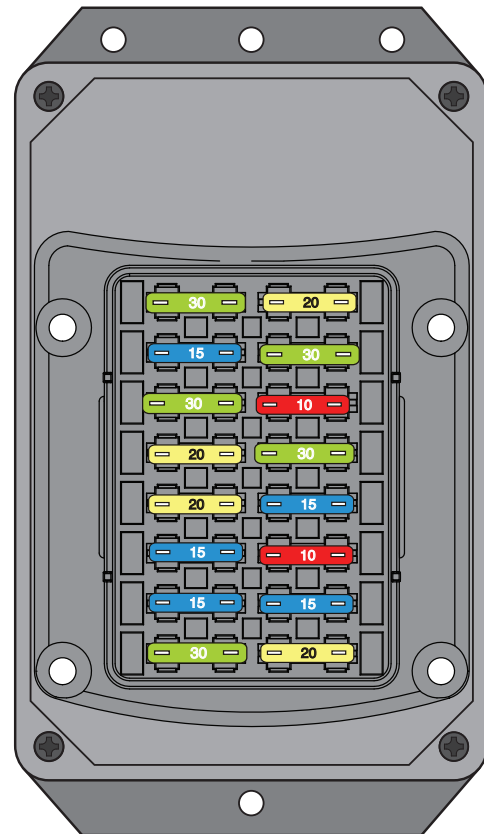

**Fuse/Circuit table**

Fuse #	Fuse Block Cover Label	Fuse Rating	Description
1	Bat-Spare	30A	Battery feed for Headlight relays.
2	Clock - Bat	15A	Battery feed for a Clock and a Radio.
3	Power Seats	30A	Battery feed for optional Power Seats.
4	Cigar Lighter	20A	Battery feed for the Cigarette Lighter.
5	Pwr Locks	20A	Battery feed to Power Locks. Fog sw.
6	Stop / Courtesy	15A	Battery feed for Brake Lights, Dash Lights, Courtesy and Dome Lights, to Rear Body Harness for options and the Glove Box Light.
7	Hazard	15A	Battery feed for optional Hazard Lights and optional battery feed.
8	Power Window	30A	Ignition feed for optional Power Windows.
9	Wiper	20A	12V Accessory feed for Wiper/Washer system.
10	Heat / AC	30A	12V Accessory feed for Heater/AC System.
11	Radio	10A	12V Accessory "on-off" feed to Radio.
12	Engine Fan	30A	12V Accessory for an optional Electric Fan System, Relay key-on trigger
13	Turn	15A	Ignition feed for the Turn Signals.
14	Gauges, B/U	10A	Ignition feed for Dash Gauges/Warning Lights and Back-up Lights.
15	Electric Choke	15A	Ignition feed for an Electric Choke,
16	Fuel Pump	20A	Ignition feed for an Electric Fuel Pump and optional Electronic Speedometer System.

**STEP 3: RECONNECT YOUR BATTERY:**

When you have completed the installation and are ready to reconnect the battery, make sure that the following electrical system grounds are in place:

- A. Battery is grounded to the ENGINE BLOCK.
- B. Battery is grounded to the frame.
- C. Engine block is grounded to the frame.
- D. Body is grounded to the frame.

**STEP 4: CHECK ALL ELECTRICAL FUNCTIONS:**

Any non-functioning items should be checked for proper installation. Any problems with your wiring and electrical circuit functions, should be addressed to American Autowire Systems, Inc. as soon as possible, to avoid any warranty problems.

If you have any questions concerning this or any of our products, please feel free to call us at 1-856-933-0801.



**American Autowire**

**1964-66 Mustang**

Classic Update Series

**510125**

92973555 Rev 2.0 3/1/2024

www.americanautowire.com 856-933-0801

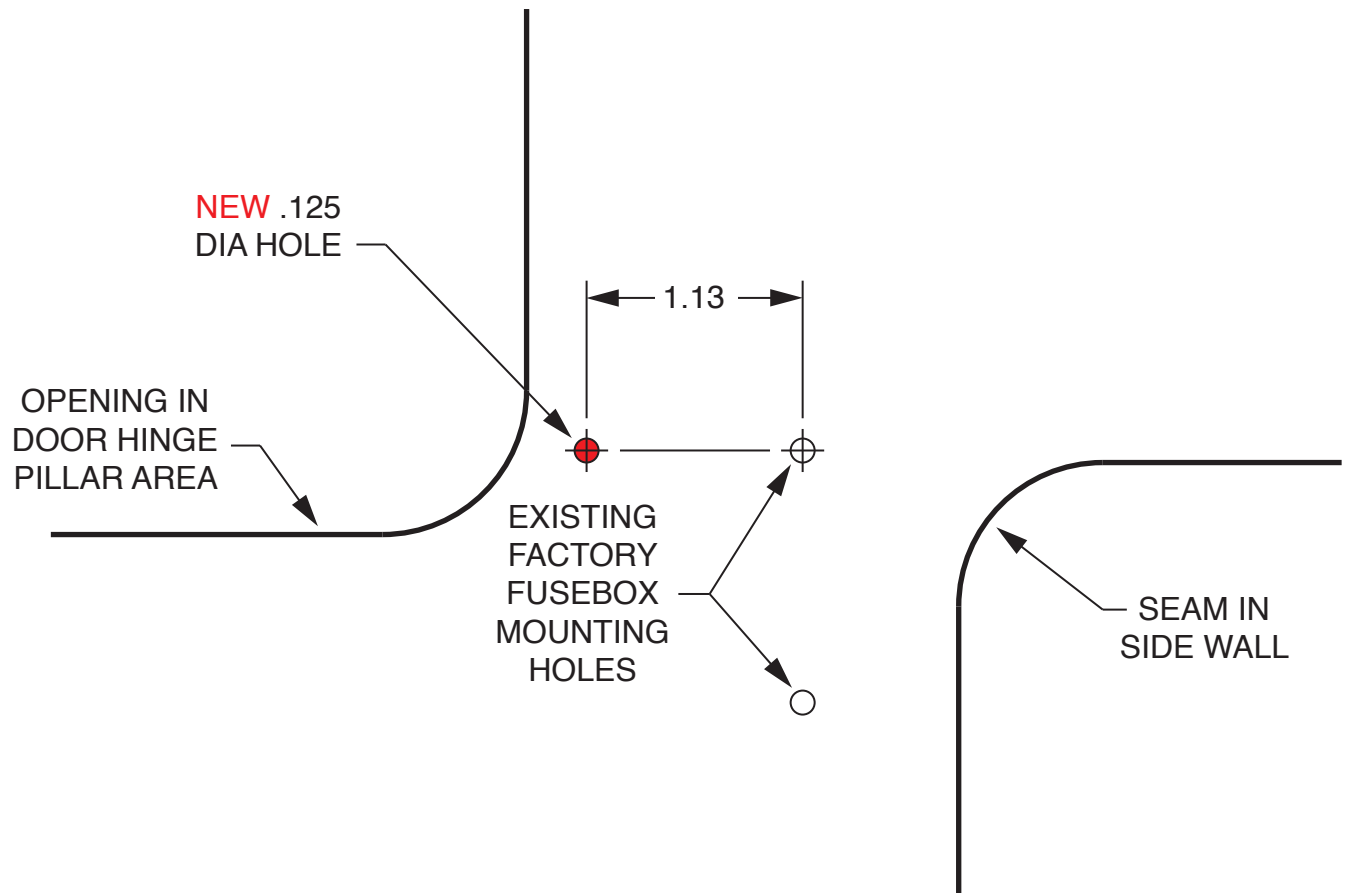

1. Position the template against the driver-side door hinge pillar area. Using the lower right corner of the opening that shows the upper door hinge mounting bolts and the existing factory fusebox mounting holes as guides, align the template as shown.

2. Drill one new 0.125 hole as shown above.

3. Attach the fuse box mounting bracket, box and harness assembly to the door hinge pillar area (with the fuse opening position facing down toward the floor of your vehicle) using the (2) new fuse box mounting screws "F" and lock washers "G" provided in the **92972060** dash loose piece kit. For reference, please see the detail photos of the assembled box, bracket and harness assembly installed in a car on the **92972102 (510125)** main instruction set.

**PRINT ON ADHESIVE LABEL SHEET**

**92972154**

1964-66 Ford Mustang fusebox mounting template instructions

Rev 0.0 2/8/2018

PRINTING INSTRUCTIONS: ***DO NOT FIT TO PAGE OR SCALE***



faces towards rear of car

NEW .125  
DIA HOLES  
2 PLACES

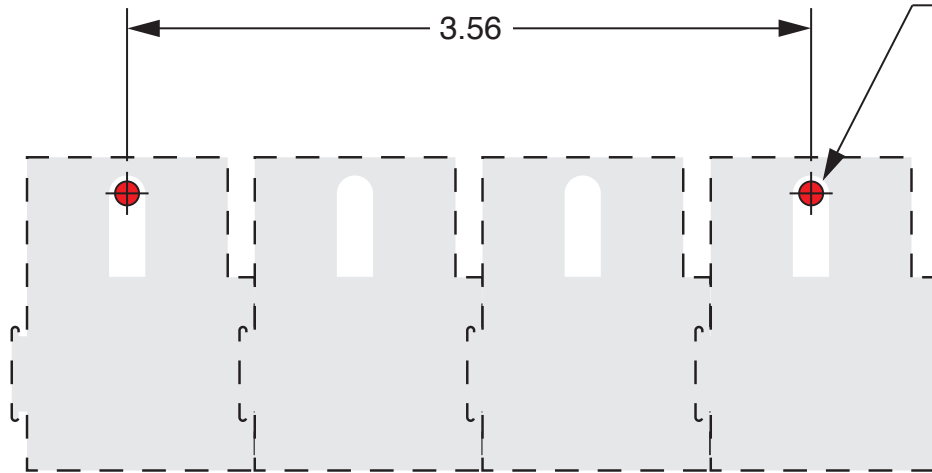

faces towards front of car

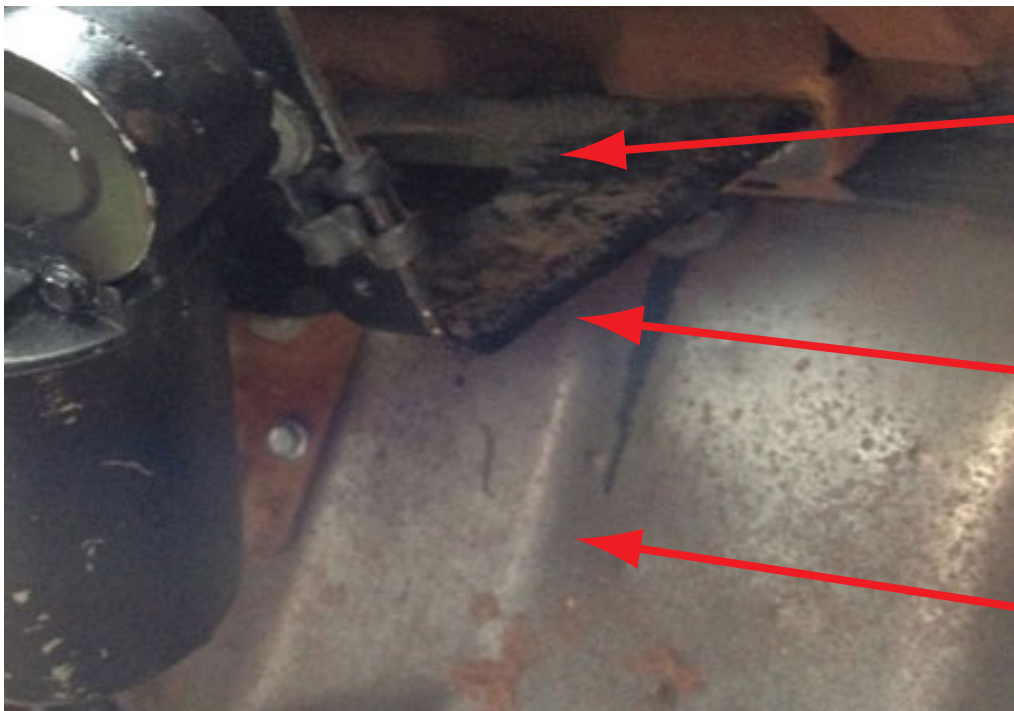

Wiper motor  
support bracket

Your 4-way relay  
bank will install  
from the right side  
and will mount to  
the underside of  
the wiper motor  
support bracket.

Firewall/Toeboard

1. Use the template at the top of this page to drill two .125 mounting holes in your wiper motor support bracket to mount the bank of 4 relays (**screws not included**).

2. The 4-way relay bank shown on the main instruction set, **92972102**, will mount here with the wiring portion coming out toward the passenger side of the car.

3. Once you have mounted the relay bank, plug the 4 relays into the relay bases to complete this part of the installation.

**PRINT ON ADHESIVE  
LABEL SHEET**

**92972156**

1964-68 Ford Mustang relay bank  
mounting template instructions

Rev 0.0 7/16/2018

PRINTING INSTRUCTIONS: **DO NOT FIT TO PAGE OR SCALE**

A  (1)  
 (144.0" 6 Gauge charge wire)

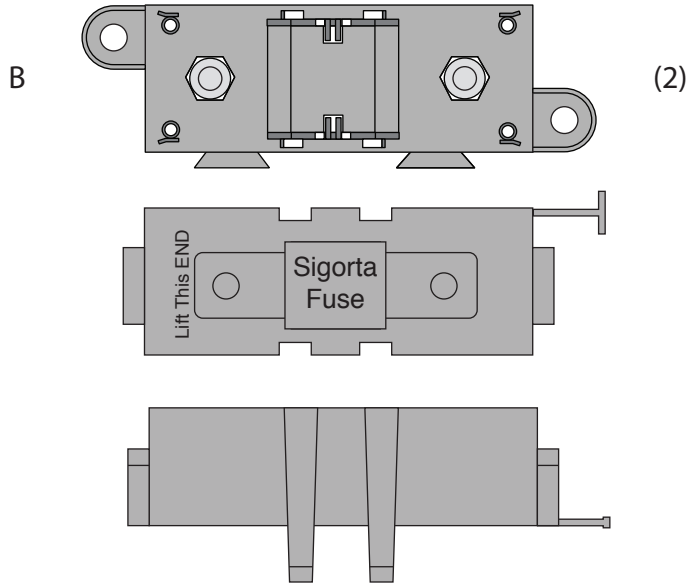

1. On this page, you will find the wire, fuse bodies, fuses, boot, ring terminals, and shrink tubing (items A through K) that are necessary to connect your alternator and main power feed for your new AAW wiring kit. Please be sure that all of the necessary components are present before starting this portion of your installation. If anything is missing, stop what you are doing and contact AAW at the number listed below right away.

2. On page 2, you will find directions for building the 2 Megafuse assemblies (items B,C and D) into one unit.

3. On page 3, you will find an overall concept of how to connect the Megafuse assemblies to your starter solenoid, alternator and main power feed of your new wiring system.

4. On page 4, you will find tips on building your charging circuit wires and assembling them and the main panel power feed wire to the Megafuse assemblies.

(Megafuse body, cover and two M8 x 1.25 nuts / lock washers)

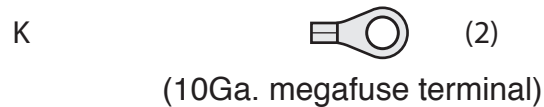
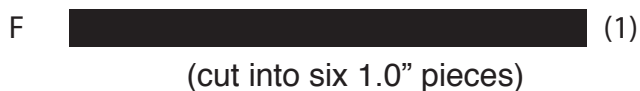
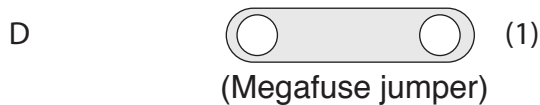
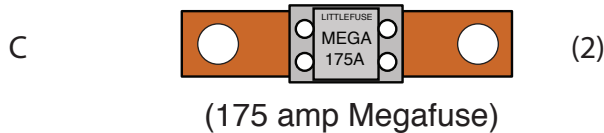

www.americanautowire.com 856-933-0801

PART #

510476

Z

DESCRIPTION:

Alternator and Main Power  
 Connection Kit  
 Various Applications

92972153 instruction sheet rev 0.1 6/24/2019

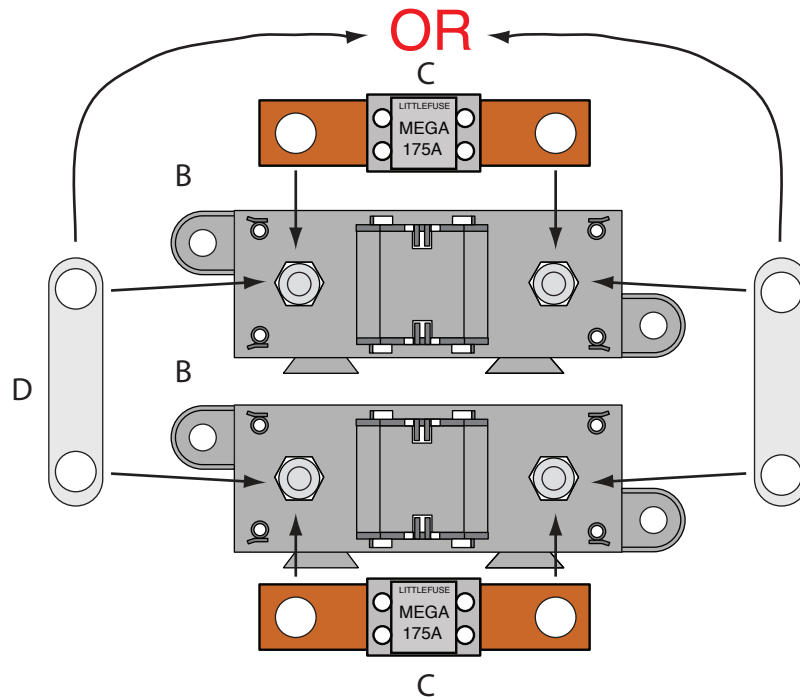

## Assembling the (2) Megafuse assemblies

**NOTE:** Find a suitable place, as close to the battery power source as possible, under the hood of your vehicle to mount the completed Megafuse assemblies. Keep in mind that you have 12 feet of 6Ga. charging wire, and that the main power feed coming from your panel or bulkhead connection must also be able to reach the assembly.

1. Take the two Megafuse bodies and covers (items B) and snap them together. Remove the 4 nuts and lock washers from the studs on the fuse body assemblies.
2. Install the Megafuse jumper (item D above) over two of the studs on the Megafuse bodies. It is very important that the jumper **MUST BE** assembled on the side that is going to connect to your main power connection (starter solenoid or battery feed).
3. Notch top cover to clear jumper D as shown at right.
4. Snap one 175amp fuse (items C) onto the studs of each of the two Megafuse bodies (items B), over the jumper, then loosely re-attach the 4 nuts and lock washers back onto the assembled Megafuses. The fuse assemblies are ready to install into your vehicle.

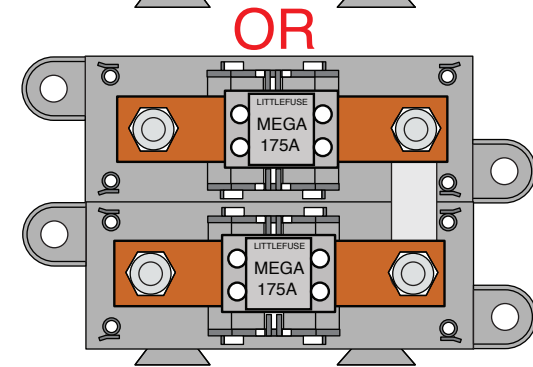
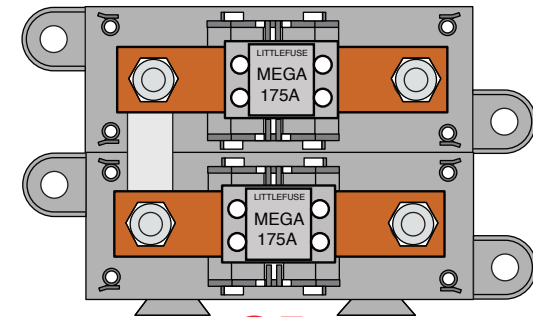

## Assembled Megafuses

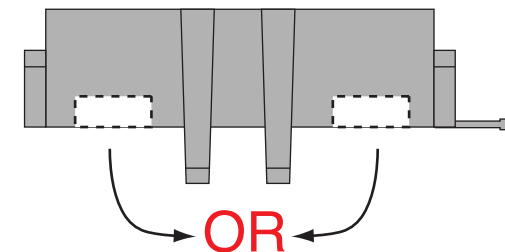

## Notched Cover

PART #

**510476**

**Z**

DESCRIPTION:

Alternator and Main Power  
Connection Kit  
Various Applications

92972153 instruction sheet rev 0.1 6/24/2019



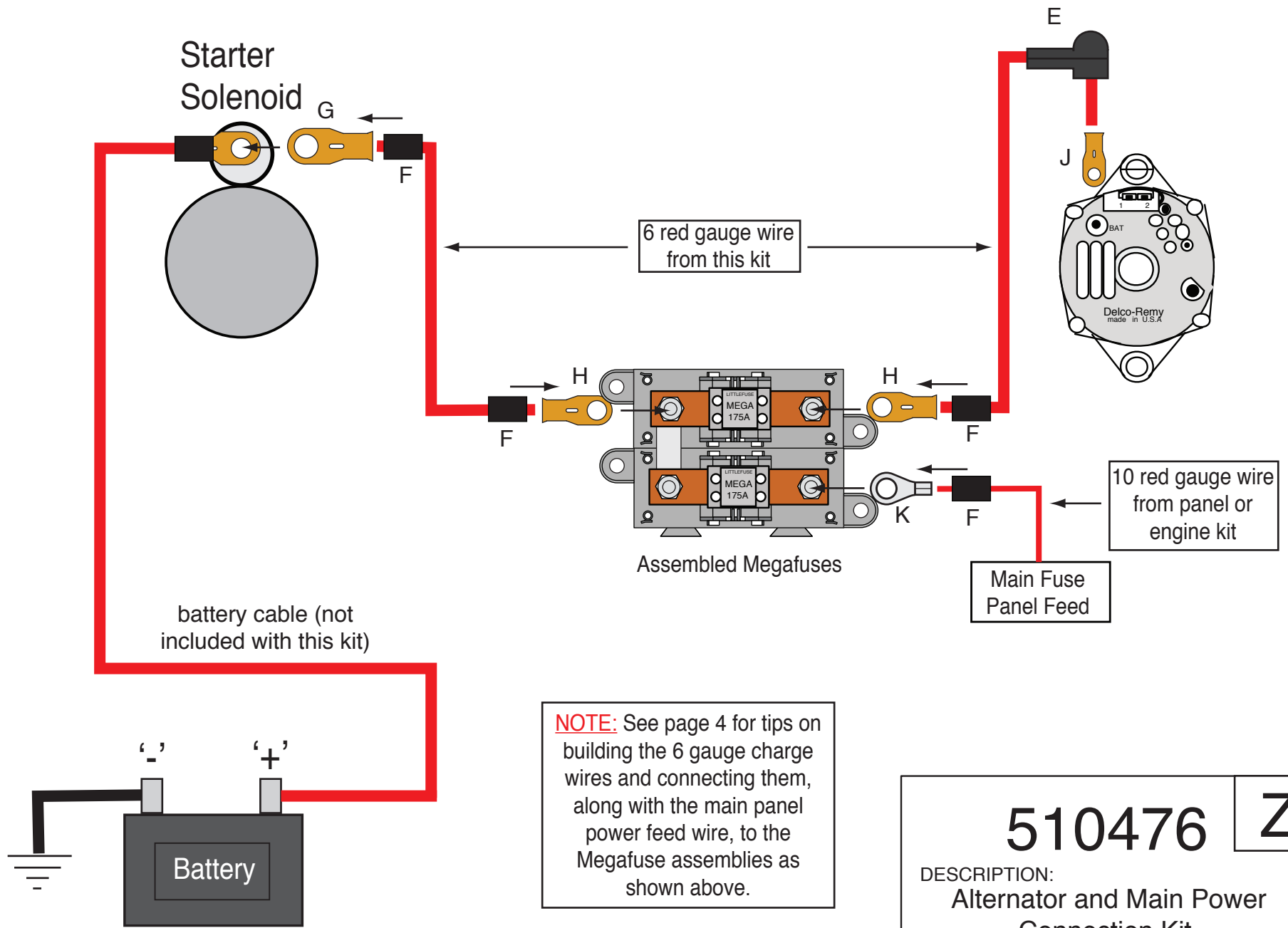

**NOTE:** See page 4 for tips on building the 6 gauge charge wires and connecting them, along with the main panel power feed wire, to the Megafuse assemblies as shown above.

<h1>510476</h1>	<b>Z</b>
<p>DESCRIPTION:  <b>Alternator and Main Power Connection Kit</b>  <b>Various Applications</b></p>	
<p>92972153 instruction sheet rev 0.1 6/24/2019</p>	

## **Building the 6Ga. charge wires and connecting them and the main panel power feed wire to the Megafuse assemblies:**

**NOTE:** Make sure that your battery is disconnected! You will need to install the preassembled Megafuses from page 2 in your vehicle to start this part of the installation.

1. Pre-cut item F shrink tubing into (6) 1.00" - 1.25" pieces.
2. Take the 12-foot piece of 6Ga. red wire from this kit and route it from your starter (or other battery feed) over to the area where you have mounted your Megafuse and cut it to length. Strip the insulation on each end back 1/2". Install 2 pieces of shrink tubing F onto the wire. At the starter end, crimp and solder (1) of terminal G onto the wire. At the Megafuse end, crimp and solder (1) of terminal H onto the wire. Slide the shrink tubing over the terminals and heat it up to shrink it down.
3. Take the remaining portion of the 12-foot piece of 6Ga. red wire from this kit and route it from your alternator over to the area where you have mounted your Megafuse and cut it to length. Strip the insulation on each end back 1/2". Install 1 piece of shrink tubing F onto the wire. At the alternator end, slip on boot E as shown on page 3, then crimp and solder (1) of terminal J onto the wire. At the Megafuse end, crimp and solder (1) of terminal H onto the wire. Slide the shrink tubing over terminal H and heat it up to shrink it down.
4. Take the 10Ga. red main power feed wire from your engine or panel sub-kit and route it over to the area where you have mounted your Megafuse and cut it to length. Strip the insulation back 3/8". Install 1 piece of shrink tubing F onto the wire, then crimp and solder (1) of terminal K onto the wire.
5. Remove the 4 loosely tightened nuts and lock washers from the assembled Megafuses, then using the drawing on page 3 as a guide, install your pre-assembled wires from steps 2-4 above. Re-install the 4 nuts and lock washers onto the assembled Megafuses and tighten them down. This part of your installation is now complete.

**510476**

**Z**

DESCRIPTION:

**Alternator and Main Power  
Connection Kit  
Various Applications**

92972153 instruction sheet rev 0.1 6/24/2019

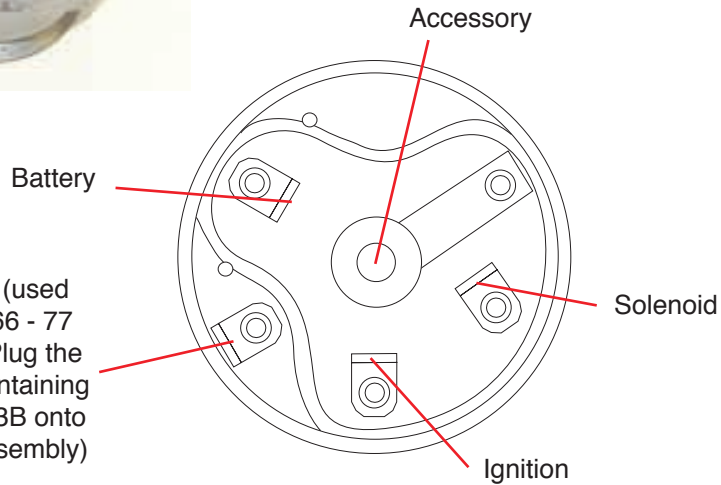

150 Heller Pl #17 W Bellmawr, NJ 08031 856-933-0801

PART #

**510128**

DESCRIPTION:

Ignition Switch  
Various Ford Applications  
Classic Update Series

92969235 instruction sheet rev 2.0 2/4/2014

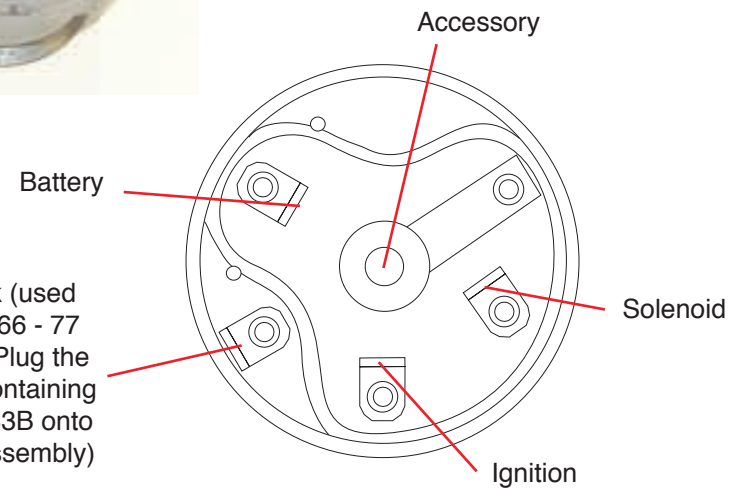

150 Heller Pl #17 W Bellmawr, NJ 08031 856-933-0801

PART #

**510128**

DESCRIPTION:

Ignition Switch  
Various Ford Applications  
Classic Update Series

92969235 instruction sheet rev 2.0 2/4/2014



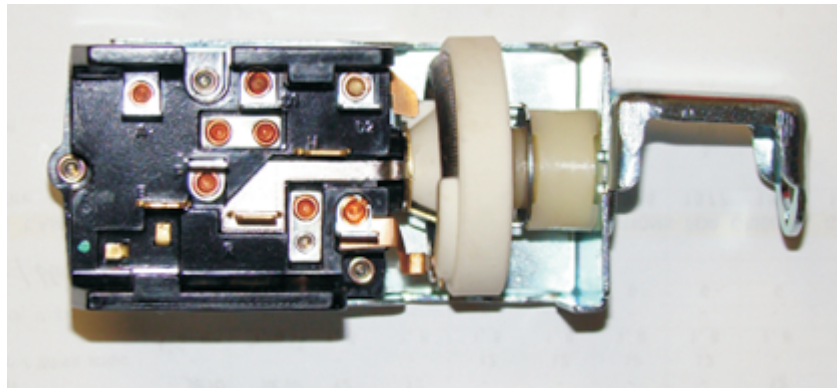
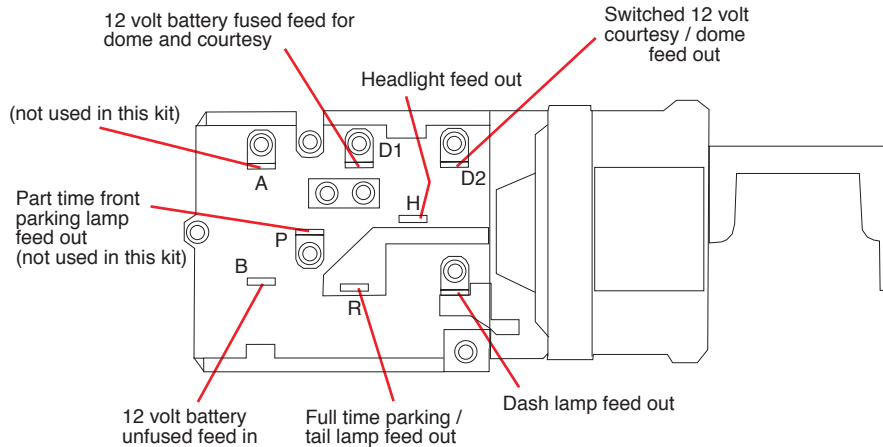

**NOTE:** Some early production 1964 1/2 Mustangs used a unique headlight switch assembly that utilized a shorter knob and shaft assembly than the later production 65 - 66 Mustang and 1965 Falcons used (3.63" vs. 3.90"). Your new AAW switch needs the later production style knob and shaft in order to operate. If you are using this switch on an early production 1964 1/2 Mustang, you will need to purchase the newer long style knob and shaft assembly from your favorite Mustang parts supplier as your original will be too short to operate this new switch.



www.americanautowire.com 856-933-0801

PART #

**510054**

DESCRIPTION:

Headlight Switch  
Various Ford Models  
Classic Update Series

92968933 instruction sheet rev 3.0 2/12/2014

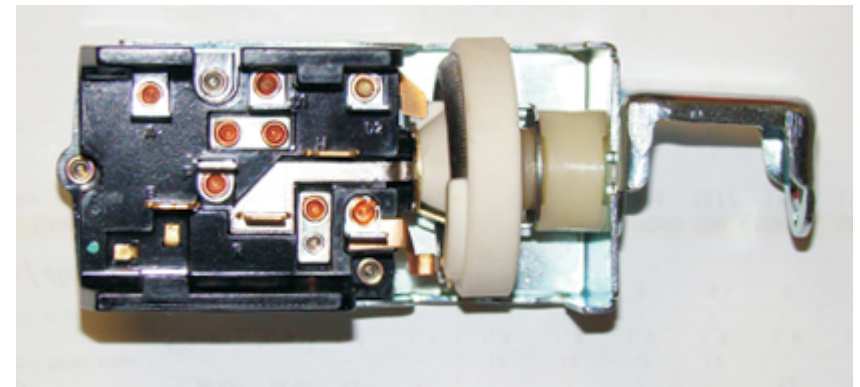
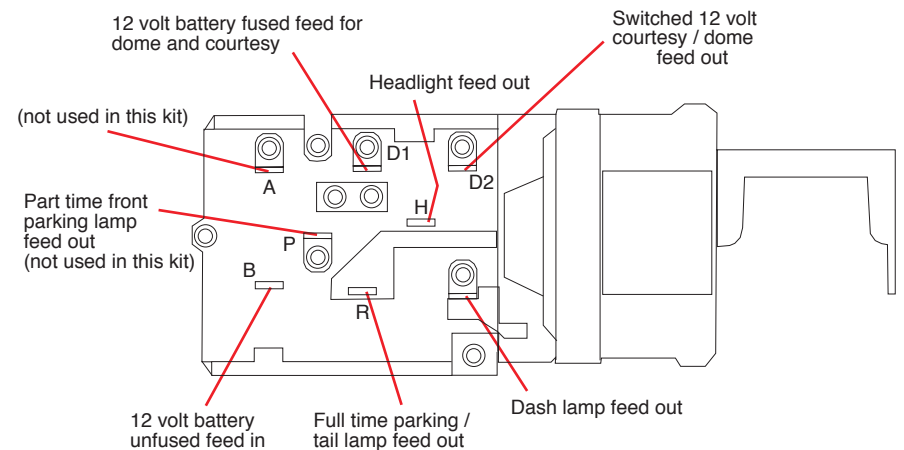

**NOTE:** Some early production 1964 1/2 Mustangs used a unique headlight switch assembly that utilized a shorter knob and shaft assembly than the later production 65 - 66 Mustang and 1965 Falcons used (3.63" vs. 3.90"). Your new AAW switch needs the later production style knob and shaft in order to operate. If you are using this switch on an early production 1964 1/2 Mustang, you will need to purchase the newer long style knob and shaft assembly from your favorite Mustang parts supplier as your original will be too short to operate this new switch.



www.americanautowire.com 856-933-0801

PART #

**510054**

DESCRIPTION:

Headlight Switch  
Various Ford Models  
Classic Update Series

92968933 instruction sheet rev 3.0 2/12/2014

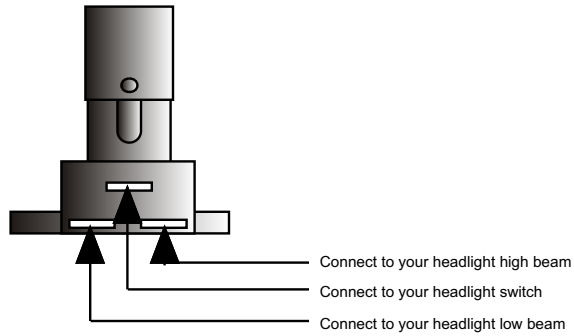

Connect the Dimmer Switch wires as shown above.

1. The top center terminal of the Dimmer Switch is connected to the Headlight switch.
2. The terminal on the right side is connected to your headlight high beam terminal.
3. The terminal on the left side is connected to your headlight low beam terminal.

another wiring product by...



150 Heller Pl #17 W Bellmawr, NJ 08031 856-933-0801

PART #

**500042**

DESCRIPTION:

**DIMMER SWITCH**

92964573 instruction sheet Rev 3.0 6/29/99

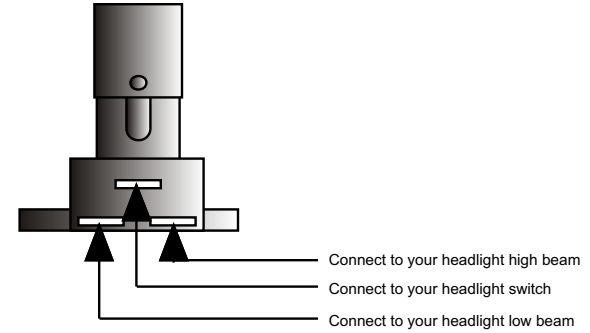

Connect the Dimmer Switch wires as shown above.

1. The top center terminal of the Dimmer Switch is connected to the Headlight switch.
2. The terminal on the right side is connected to your headlight high beam terminal.
3. The terminal on the left side is connected to your headlight low beam terminal.

another wiring product by...



150 Heller Pl #17 W Bellmawr, NJ 08031 856-933-0801

PART #

**500042**

DESCRIPTION:

**DIMMER SWITCH**

92964573 instruction sheet Rev 3.0 6/29/99